

## OPAx171 36-V, Single-Supply, SOT-553, General-Purpose Operational Amplifiers

### 1 Features

- Supply range: 2.7 to 36 V,  $\pm 1.35$  V to  $\pm 18$  V
- Low noise:  $14 \text{ nV}/\sqrt{\text{Hz}}$
- Low offset drift:  $\pm 0.3 \mu\text{V}/^\circ\text{C}$  (typical)
- RFI filtered inputs
- Input range includes the negative supply
- Input range operates to positive supply
- Rail-to-rail output
- Gain bandwidth: 3 MHz
- Low quiescent current: 475  $\mu\text{A}$  per amplifier
- High common-mode rejection: 120 dB (typical)
- Low-input bias current: 8 pA
- Industry-standard packages:
  - 8-pin SOIC
  - 8-pin MSOP
  - 14-pin TSSOP
- *Micro packages:*
  - Single in SOT-553
  - Dual in VSSOP-8

### 2 Applications

- [Tracking amplifier in power modules](#)
- [Merchant power supplies](#)
- [Transducer amplifiers](#)
- [Bridge amplifiers](#)
- [Temperature measurements](#)
- [Strain gauge amplifiers](#)
- [Precision integrators](#)
- [Battery-powered instruments](#)
- [Test equipment](#)

### 3 Description

The OPA171, OPA2171, and OPA4171 (OPAx171) are a family of 36-V, single-supply, low-noise operational amplifiers with the ability to operate on supplies ranging from 2.7 V ( $\pm 1.35$  V) to 36 V ( $\pm 18$  V). These devices are available in micro-packages and offer low offset, drift, and bandwidth with low quiescent current. The single, dual, and quad versions all have identical specifications for maximum design flexibility.

Unlike most operational amplifiers, which are specified at only one supply voltage, the OPAx171 family is specified from 2.7 to 36 V. Input signals beyond the supply rails do not cause phase reversal. The OPAx171 family is stable with capacitive loads up to 300 pF. The input can operate 100 mV below the negative rail and within 2 V of the top rail during normal operation. These devices can operate with full rail-to-rail input 100 mV beyond the top rail, but with reduced performance within 2 V of the top rail.

The OPAx171 series of operational amplifiers are specified from  $-40^\circ\text{C}$  to  $+125^\circ\text{C}$ .

#### Device Information<sup>(1)</sup>

| PART NUMBER | PACKAGE    | BODY SIZE (NOM)   |
|-------------|------------|-------------------|
| OPA171      | SOT-23 (5) | 1.60 mm × 2.90 mm |
| OPA2171     | SOIC (8)   | 3.90 mm × 4.90 mm |
| OPA4171     | TSSOP (14) | 4.40 mm × 5.00 mm |
|             | SOIC (14)  | 3.90 mm × 8.65 mm |

(1) For all available packages, see the orderable addendum at the end of the data sheet.

#### Offset Voltage vs Common-Mode Voltage

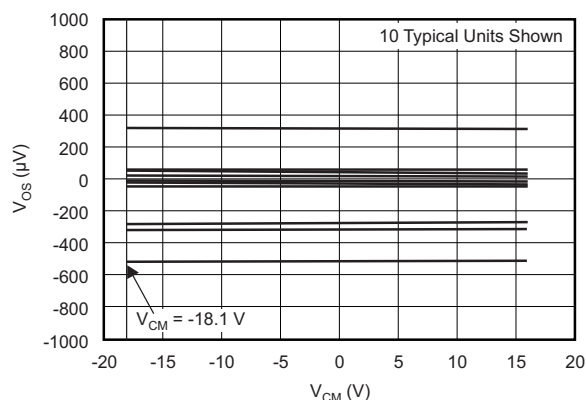

#### Offset Voltage vs Power Supply

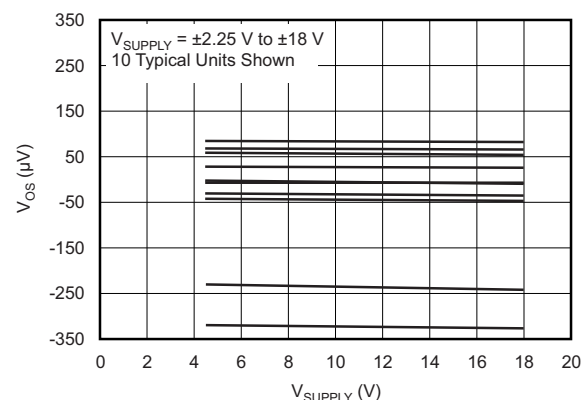

## Table of Contents

|  |           |  |           |
|--|-----------|--|-----------|
| <b>1 Features</b> .....                        | <b>1</b>  | 7.3 Feature Description .....                                    | <b>18</b> |
| <b>2 Applications</b> .....                    | <b>1</b>  | 7.4 Device Functional Modes .....                                | <b>20</b> |
| <b>3 Description</b> .....                     | <b>1</b>  | <b>8 Application and Implementation</b> .....                    | <b>21</b> |
| <b>4 Revision History</b> .....                | <b>2</b>  | 8.1 Application Information .....                                | <b>21</b> |
| <b>5 Pin Configuration and Functions</b> ..... | <b>4</b>  | 8.2 Typical Application .....                                    | <b>23</b> |
| <b>6 Specifications</b> .....                  | <b>7</b>  | <b>9 Power Supply Recommendations</b> .....                      | <b>27</b> |
| 6.1 Absolute Maximum Ratings .....             | <b>7</b>  | <b>10 Layout</b> .....   | <b>27</b> |
| 6.2 ESD Ratings .....                          | <b>7</b>  | 10.1 Layout Guidelines .....                                     | <b>27</b> |
| 6.3 Recommended Operating Conditions .....     | <b>7</b>  | 10.2 Layout Example .....  | <b>27</b> |
| 6.4 Thermal Information: OPA171 .....          | <b>8</b>  | <b>11 Device and Documentation Support</b> .....                 | <b>28</b> |
| 6.5 Thermal Information: OPA2171 .....         | <b>8</b>  | 11.1 Related Links .....   | <b>28</b> |
| 6.6 Thermal Information: OPA4171 .....         | <b>8</b>  | 11.2 Support Resources .....                                     | <b>28</b> |
| 6.7 Electrical Characteristics .....           | <b>9</b>  | 11.3 Trademarks .....  | <b>28</b> |
| 6.8 Typical Characteristics .....              | <b>12</b> | 11.4 Electrostatic Discharge Caution .....                       | <b>28</b> |
| <b>7 Detailed Description</b> .....            | <b>18</b> | 11.5 Glossary .....  | <b>28</b> |
| 7.1 Overview .....                             | <b>18</b> | <b>12 Mechanical, Packaging, and Orderable Information</b> ..... | <b>28</b> |
| 7.2 Functional Block Diagram .....             | <b>18</b> |  |           |

## 4 Revision History

NOTE: Page numbers for previous revisions may differ from page numbers in the current version.

| <b>Changes from Revision F (April 2018) to Revision G</b>   | <b>Page</b> |
|---|-------------|
| • Added links to <i>Applications</i> .....  | <b>1</b>    |
| • Changed graphs with incorrect units (mV to $\mu$ V) in the <i>Typical Characteristics</i> section ..... | <b>12</b>   |

| <b>Changes from Revision E (April 2015) to Revision F</b>  | <b>Page</b> |
|--|-------------|
| • Changed minimum supply voltage value from $\pm 20$ V to 0 V in <i>Absolute Maximum Ratings</i> table ..... | <b>7</b>    |
| • Added maximum supply voltage value of 40 V to <i>Absolute Maximum Ratings</i> table .....                  | <b>7</b>    |
| • Rewrote <i>Electrical Overstress</i> subsection content in <i>Application Information</i> section .....    | <b>21</b>   |

| <b>Changes from Revision D (September 2012) to Revision E</b>  | <b>Page</b> |
|--|-------------|
| • Changed device title (removed "Value Line Series") .....   | <b>1</b>    |
| • Added <i>ESD Ratings</i> table, <i>Feature Description</i> section, <i>Device Functional Modes</i> , <i>Application and Implementation</i> section, <i>Power Supply Recommendations</i> section, <i>Layout</i> section, <i>Device and Documentation Support</i> section, and <i>Mechanical, Packaging, and Orderable Information</i> section ..... | <b>1</b>    |

| <b>Changes from Revision C (June 2011) to Revision D</b> | <b>Page</b> |
|--|-------------|
| • Added "Value Line Series" to title .....               | <b>1</b>    |

| <b>Changes from Revision B (November 2010) to Revision C</b>      | <b>Page</b> |
|---|-------------|
| • Added MSOP-8 package to device graphic .....                    | <b>1</b>    |
| • Added MSOP-8 package to Features bullets .....                  | <b>1</b>    |
| • Added MSOP-8 package to Product Family table .....              | <b>1</b>    |
| • Updated pinout configurations for OPA2171 and OPA4171 .....     | <b>4</b>    |
| • Added MSOP-8 package to OPA2171 Thermal Information table ..... | <b>8</b>    |

- Added new row for Voltage Output Swing from Rail parameter to *Output* subsection of *Electrical Characteristics*..... 10
- Changed Voltage Output Swing from Rail parameter to over temperature in *Output* subsection of *Electrical Characteristics* ..... 10
- Changed [Figure 9](#) ..... 12

---

| <b>Changes from Revision A (November, 2010) to Revision B</b>                   | <b>Page</b> |
|---|-------------|
| • Changed input offset voltage specification .....                              | 9           |
| • Changed input offset voltage, over temperature specification .....            | 9           |
| • Changed quiescent current per amplifier, over temperature specification ..... | 10          |

## 5 Pin Configuration and Functions

**OPA171 DRL Package  
5-Pin SOT-553  
Top View**

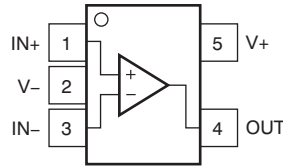

**OPA171 DBV Package  
5-Pin SOT-23  
Top View**

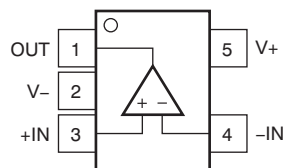

**OPA171 D Package  
8-Pin SOIC  
Top View**

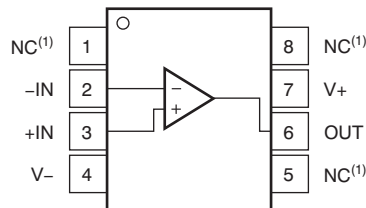

(1) NC - no internal connection

**Pin Functions: OPA171**

| NAME | PIN |     |         | I/O | DESCRIPTION                                   |
|------|-----|-----|---------|-----|---|
|      | DRL | DBV | D       |     |   |
| +IN  | 1   | 3   | 3       | I   | Noninverting input                            |
| -IN  | 3   | 4   | 2       | I   | Inverting input                               |
| OUT  | 4   | 1   | 6       | O   | Output  |
| V+   | 5   | 5   | 7       | —   | Positive (highest) supply                     |
| V-   | 2   | 2   | 4       | —   | Negative (lowest) supply                      |
| NC   | —   | —   | 1, 5, 8 | —   | No internal connection (can be left floating) |

**OPA2171 D, DCU, and DCK Packages  
8-Pin SO, VSSOP and MSOP  
Top View**

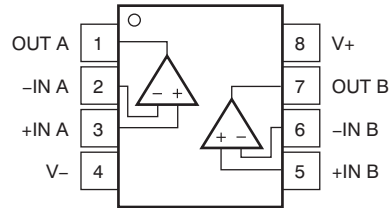

**Pin Functions: OPA2171**

| PIN   |     | I/O | DESCRIPTION               |
|-------|-----|-----|---------------------------|
| NAME  | NO. |     |                           |
| +IN A | 3   | I   | Noninverting input        |
| +IN B | 5   | I   | Noninverting input        |
| -IN A | 2   | I   | Inverting input           |
| -IN B | 6   | O   | Inverting input           |
| OUT A | 1   | O   | Output                    |
| OUT B | 7   | —   | Output                    |
| V+    | 8   | —   | Positive (highest) supply |
| V-    | 4   | —   | Negative (lowest) supply  |

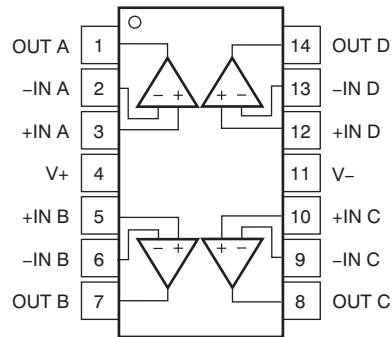
**OPA4171 D and PW Packages  
14-Pin SO and TSSOP  
Top View**

**Pin Functions: OPA4171**

| PIN   |     | I/O | DESCRIPTION               |
|-------|-----|-----|---------------------------|
| NAME  | NO. |     |                           |
| +IN A | 3   | I   | Noninverting input        |
| +IN B | 5   | I   | Noninverting input        |
| +IN C | 10  | I   | Noninverting input        |
| +IN D | 12  | I   | Noninverting input        |
| -IN A | 2   | I   | Inverting input           |
| -IN B | 6   | I   | Inverting input           |
| -IN C | 9   | I   | Inverting input           |
| -IN D | 13  | I   | Inverting input           |
| OUT A | 1   | O   | Output                    |
| OUT B | 7   | O   | Output                    |
| OUT C | 8   | O   | Output                    |
| OUT D | 14  | O   | Output                    |
| V+    | 4   | —   | Positive (highest) supply |
| V-    | 11  | —   | Negative (lowest) supply  |

## 6 Specifications

### 6.1 Absolute Maximum Ratings

over operating free-air temperature range, (unless otherwise noted) <sup>(1)</sup>

|                                     |         | MIN                     | MAX                     | UNIT |
|-------------------------------------|---------|-------------------------|-------------------------|------|
| Supply voltage                      |         | 0                       | 40                      | V    |
| Signal input terminals              | Voltage | (V <sub>-</sub> ) – 0.5 | (V <sub>+</sub> ) + 0.5 | V    |
|                                     | Current | –10                     | 10                      | mA   |
| Output short circuit <sup>(2)</sup> |         | Continuous              |                         |      |
| Operating temperature               |         | –55                     | 150                     | °C   |
| Junction temperature                |         |                         | 150                     | °C   |
| Storage temperature                 |         | –65                     | 150                     | °C   |

(1) Stresses beyond those listed under *Absolute Maximum Ratings* may cause permanent damage to the device. These are stress ratings only, which do not imply functional operation of the device at these or any other conditions beyond those indicated under *Recommended Operating Conditions*. Exposure to absolute-maximum-rated conditions for extended periods may affect device reliability.

(2) Short-circuit to ground, one amplifier per package.

### 6.2 ESD Ratings

|                    |                         |  | VALUE | UNIT |
|--------------------|-------------------------|--|-------|------|
| V <sub>(ESD)</sub> | Electrostatic discharge | Human-body model (HBM), per ANSI/ESDA/JEDEC JS-001 <sup>(1)</sup>              | ±4000 | V    |
|                    |                         | Charged-device model (CDM), per JEDEC specification JESD22-C101 <sup>(2)</sup> | ±750  |      |

(1) JEDEC document JEP155 states that 500-V HBM allows safe manufacturing with a standard ESD control process.

(2) JEDEC document JEP157 states that 250-V CDM allows safe manufacturing with a standard ESD control process.

### 6.3 Recommended Operating Conditions

over operating free-air temperature range (unless otherwise noted)

|   | MIN         | NOM | MAX      | UNIT |
|---|-------------|-----|----------|------|
| Supply voltage (V <sub>+</sub> – V <sub>-</sub> ) | 4.5 (±2.25) |     | 36 (±18) | V    |
| Specified temperature                             | –40         |     | 125      | °C   |

## 6.4 Thermal Information: OPA171

| THERMAL METRIC <sup>(1)</sup> |  | OPA171 |              |               | UNIT |
|-------------------------------|--|--------|--------------|---------------|------|
|                               |  | D (SO) | DBV (SOT-23) | DRL (SOT-553) |      |
|                               |  | 8 PINS | 5 PINS       | 5 PINS        |      |
| $R_{\theta JA}$               | Junction-to-ambient thermal resistance       | 149.5  | 245.8        | 208.1         | °C/W |
| $R_{\theta JC(top)}$          | Junction-to-case(top) thermal resistance     | 97.9   | 133.9        | 0.1           | °C/W |
| $R_{\theta JB}$               | Junction-to-board thermal resistance         | 87.7   | 83.6         | 42.4          | °C/W |
| $\Psi_{JT}$                   | Junction-to-top characterization parameter   | 35.5   | 18.2         | 0.5           | °C/W |
| $\Psi_{JB}$                   | Junction-to-board characterization parameter | 89.5   | 83.1         | 42.2          | °C/W |
| $R_{\theta JC(bot)}$          | Junction-to-case(bottom) thermal resistance  | N/A    | N/A          | N/A           | °C/W |

- (1) For more information about traditional and new thermal metrics, see the [Semiconductor and IC Package Thermal Metrics](#) application report.

## 6.5 Thermal Information: OPA2171

| THERMAL METRIC <sup>(1)</sup> |  | OPA2171 |            |             | UNIT |
|-------------------------------|--|---------|------------|-------------|------|
|                               |  | D (SO)  | DGK (MSOP) | DCU (VSSOP) |      |
|                               |  | 8 PINS  | 8 PINS     | 8 PINS      |      |
| $R_{\theta JA}$               | Junction-to-ambient thermal resistance       | 134.3   | 175.2      | 195.3       | °C/W |
| $R_{\theta JC(top)}$          | Junction-to-case(top) thermal resistance     | 72.1    | 74.9       | 59.4        | °C/W |
| $R_{\theta JB}$               | Junction-to-board thermal resistance         | 60.6    | 22.2       | 115.1       | °C/W |
| $\Psi_{JT}$                   | Junction-to-top characterization parameter   | 18.2    | 1.6        | 4.7         | °C/W |
| $\Psi_{JB}$                   | Junction-to-board characterization parameter | 53.8    | 22.8       | 114.4       | °C/W |
| $R_{\theta JC(bot)}$          | Junction-to-case(bottom) thermal resistance  | N/A     | N/A        | N/A         | °C/W |

- (1) For more information about traditional and new thermal metrics, see the [Semiconductor and IC Package Thermal Metrics](#) application report .

## 6.6 Thermal Information: OPA4171

| THERMAL METRIC <sup>(1)</sup> |  | OPA4171  |            | UNIT |
|-------------------------------|--|----------|------------|------|
|                               |  | D (SOIC) | PW (TSSOP) |      |
|                               |  | 14 PINS  | 14 PINS    |      |
| $R_{\theta JA}$               | Junction-to-ambient thermal resistance       | 93.2     | 106.9      | °C/W |
| $R_{\theta JC(top)}$          | Junction-to-case(top) thermal resistance     | 51.8     | 24.4       | °C/W |
| $R_{\theta JB}$               | Junction-to-board thermal resistance         | 49.4     | 59.3       | °C/W |
| $\Psi_{JT}$                   | Junction-to-top characterization parameter   | 13.5     | 0.6        | °C/W |
| $\Psi_{JB}$                   | Junction-to-board characterization parameter | 42.2     | 54.3       | °C/W |
| $R_{\theta JC(bot)}$          | Junction-to-case(bottom) thermal resistance  | N/A      | N/A        | °C/W |

- (1) For more information about traditional and new thermal metrics, see the [Semiconductor and IC Package Thermal Metrics](#) application report.



## 6.7 Electrical Characteristics

at  $T_A = 25^\circ\text{C}$ ,  $V_S = 2.7$  to  $36\text{ V}$ ,  $V_{CM} = V_{OUT} = V_S / 2$ , and  $R_{LOAD} = 10\text{ k}\Omega$  connected to  $V_S / 2$ , (unless otherwise noted)

| PARAMETER                 |  | TEST CONDITIONS   | MIN                   | TYP               | MAX                 | UNIT                                 |
|---------------------------|--|---|-----------------------|-------------------|---------------------|--------------------------------------|
| <b>OFFSET VOLTAGE</b>     |  |   |                       |                   |                     |                                      |
| $V_{OS}$                  | Input offset voltage                     |   |                       | 0.25              | $\pm 1.8$           | mV                                   |
|                           | Over temperature                         | $T_A = -40^\circ\text{C}$ to $+125^\circ\text{C}$   |                       | 0.3               | $\pm 2$             | mV                                   |
| $dV_{OS}/dT$              | Drift                                    | $T_A = -40^\circ\text{C}$ to $+125^\circ\text{C}$   |                       | 0.3               | $\pm 2$             | $\mu\text{V}/^\circ\text{C}$         |
|                           | vs power supply                          | $V_S = 4$ to $36\text{ V}$<br>$T_A = -40^\circ\text{C}$ to $+125^\circ\text{C}$   |                       | 1                 | $\pm 3$             | $\mu\text{V}/\text{V}$               |
|                           | Channel separation, DC                   | DC  |                       | 5                 |                     | $\mu\text{V}/\text{V}$               |
| <b>INPUT BIAS CURRENT</b> |  |   |                       |                   |                     |                                      |
| $I_B$                     | Input bias current                       |   |                       | $\pm 8$           | $\pm 15$            | pA                                   |
|                           | Over temperature                         | $T_A = -40^\circ\text{C}$ to $+125^\circ\text{C}$   |                       |                   | $\pm 3.5$           | nA                                   |
| $I_{OS}$                  | Input offset current                     |   |                       | $\pm 4$           |                     | pA                                   |
|                           | Over temperature                         | $T_A = -40^\circ\text{C}$ to $+125^\circ\text{C}$   |                       |                   | $\pm 3.5$           | nA                                   |
| <b>NOISE</b>              |  |   |                       |                   |                     |                                      |
|                           | Input voltage noise                      | $f = 0.1\text{ Hz}$ to $10\text{ Hz}$   |                       | 3                 |                     | $\mu\text{V}_{PP}$                   |
| $e_n$                     | Input voltage noise density              | $f = 100\text{ Hz}$   |                       | 25                |                     | $\text{nV}/\sqrt{\text{Hz}}$         |
|                           |  | $f = 1\text{ kHz}$  |                       | 14                |                     | $\text{nV}/\sqrt{\text{Hz}}$         |
| <b>INPUT VOLTAGE</b>      |  |   |                       |                   |                     |                                      |
| $V_{CM}$                  | Common-mode voltage range <sup>(1)</sup> |   | $(V-) - 0.1\text{ V}$ |                   | $(V+) - 2\text{ V}$ | V                                    |
| CMRR                      | Common-mode rejection ratio              | $V_S = \pm 2\text{ V}$<br>$(V-) - 0.1\text{ V} < V_{CM} < (V+) - 2\text{ V}$<br>$T_A = -40^\circ\text{C}$ to $+125^\circ\text{C}$               | 90                    | 104               |                     | dB                                   |
|                           |  | $V_S = \pm 18\text{ V}$<br>$(V-) - 0.1\text{ V} < V_{CM} < (V+) - 2\text{ V}$<br>$T_A = -40^\circ\text{C}$ to $+125^\circ\text{C}$              | 104                   | 120               |                     | dB                                   |
| <b>INPUT IMPEDANCE</b>    |  |   |                       |                   |                     |                                      |
|                           | Differential                             |   |                       | $100 \parallel 3$ |                     | $\text{M}\Omega \parallel \text{pF}$ |
|                           | Common-mode                              |   |                       | $6 \parallel 3$   |                     | $10^{12}\Omega \parallel \text{pF}$  |
| <b>OPEN-LOOP GAIN</b>     |  |   |                       |                   |                     |                                      |
| $A_{OL}$                  | Open-loop voltage gain                   | $V_S = 4\text{ V}$ to $36\text{ V}$<br>$(V-) + 0.35\text{ V} < V_O < (V+) - 0.35\text{ V}$<br>$T_A = -40^\circ\text{C}$ to $+125^\circ\text{C}$ | 110                   | 130               |                     | dB                                   |
| <b>FREQUENCY RESPONSE</b> |  |   |                       |                   |                     |                                      |
| GBP                       | Gain bandwidth product                   |   |                       | 3                 |                     | MHz                                  |
| SR                        | Slew rate                                | $G = 1$   |                       | 1.5               |                     | $\text{V}/\mu\text{s}$               |
| $t_S$                     | Settling time                            | To 0.1%<br>$V_S = \pm 18\text{ V}$ , $G = 1$<br>10-V step   |                       | 6                 |                     | $\mu\text{s}$                        |
|                           |  | To 0.01% (12 bit)<br>$V_S = \pm 18\text{ V}$ , $G = 1$<br>10-V step   |                       | 10                |                     | $\mu\text{s}$                        |
|                           | Overload recovery time                   | $V_{IN} \times \text{gain} > V_S$   |                       | 2                 |                     | $\mu\text{s}$                        |
| THD+N                     | Total harmonic distortion + noise        | $G = 1$ , $f = 1\text{ kHz}$<br>$V_O = 3\text{ V}_{RMS}$  |                       | 0.0002%           |                     |                                      |
| <b>OUTPUT</b>             |  |   |                       |                   |                     |                                      |

(1) The input range can be extended beyond  $(V+) - 2\text{ V}$  up to  $V+$ . See [Typical Characteristics](#) and [Application and Implementation](#) for additional information.

**Electrical Characteristics (continued)**

 at  $T_A = 25^\circ\text{C}$ ,  $V_S = 2.7$  to  $36\text{ V}$ ,  $V_{CM} = V_{OUT} = V_S / 2$ , and  $R_{LOAD} = 10\text{ k}\Omega$  connected to  $V_S / 2$ , (unless otherwise noted)

| PARAMETER           |                                 | TEST CONDITIONS   | MIN            | TYP   | MAX            | UNIT             |
|---------------------|---------------------------------|---|----------------|---|----------------|------------------|
| $V_O$               | Voltage output swing from rail  | $V_S = 5\text{ V}$<br>$R_L = 10\text{ k}\Omega$   |                | 30  |                | mV               |
|                     | Over temperature                | $R_L = 10\text{ k}\Omega$<br>$A_{OL} \geq 110\text{ dB}$<br>$T_A = -40^\circ\text{C}$ to $+125^\circ\text{C}$ | (V-) +<br>0.35 |   | (V+) –<br>0.35 | V                |
| $I_{SC}$            | Short-circuit current           |   |                | +25/–35                                     |                | mA               |
| $C_{LOAD}$          | Capacitive load drive           |   |                | See <a href="#">Typical Characteristics</a> |                | pF               |
| $R_O$               | Open-loop output resistance     | $f = 1\text{ MHz}$<br>$I_O = 0\text{ A}$  |                | 150   |                | $\Omega$         |
| <b>POWER SUPPLY</b> |                                 |   |                |   |                |                  |
| $V_S$               | Specified voltage range         |   | 2.7            |   | 36             | V                |
| $I_Q$               | Quiescent current per amplifier | $I_O = 0\text{ A}$  |                | 475   | 595            | $\mu\text{A}$    |
|                     | Over temperature                | $I_O = 0\text{ A}$<br>$T_A = -40^\circ\text{C}$ to $+125^\circ\text{C}$                                       |                |   | 650            | $\mu\text{A}$    |
| <b>TEMPERATURE</b>  |                                 |   |                |   |                |                  |
|                     | Specified range                 |   | –40            |   | 125            | $^\circ\text{C}$ |
|                     | Operating range                 |   | –55            |   | 150            | $^\circ\text{C}$ |

**Table 1. Characteristic Performance Measurements**

| DESCRIPTION  | FIGURE  |
|--|---|
| Offset Voltage Production Distribution                         | <a href="#">Figure 1</a>                              |
| Offset Voltage Drift Distribution                              | <a href="#">Figure 2</a>                              |
| Offset Voltage vs Temperature                                  | <a href="#">Figure 3</a>                              |
| Offset Voltage vs Common-Mode Voltage                          | <a href="#">Figure 4</a>                              |
| Offset Voltage vs Common-Mode Voltage (Upper Stage)            | <a href="#">Figure 5</a>                              |
| Offset Voltage vs Power Supply                                 | <a href="#">Figure 6</a>                              |
| $I_B$ and $I_{OS}$ vs Common-Mode Voltage                      | <a href="#">Figure 7</a>                              |
| Input Bias Current vs Temperature                              | <a href="#">Figure 8</a>                              |
| Output Voltage Swing vs Output Current (Maximum Supply)        | <a href="#">Figure 9</a>                              |
| CMRR and PSRR vs Frequency (Referred-to Input)                 | <a href="#">Figure 10</a>                             |
| CMRR vs Temperature  | <a href="#">Figure 11</a>                             |
| PSRR vs Temperature  | <a href="#">Figure 12</a>                             |
| 0.1-Hz to 10-Hz Noise  | <a href="#">Figure 13</a>                             |
| Input Voltage Noise Spectral Density vs Frequency              | <a href="#">Figure 14</a>                             |
| THD+N Ratio vs Frequency                                       | <a href="#">Figure 15</a>                             |
| THD+N vs Output Amplitude                                      | <a href="#">Figure 16</a>                             |
| Quiescent Current vs Temperature                               | <a href="#">Figure 17</a>                             |
| Quiescent Current vs Supply Voltage                            | <a href="#">Figure 18</a>                             |
| Open-Loop Gain and Phase vs Frequency                          | <a href="#">Figure 19</a>                             |
| Closed-Loop Gain vs Frequency                                  | <a href="#">Figure 20</a>                             |
| Open-Loop Gain vs Temperature                                  | <a href="#">Figure 21</a>                             |
| Open-Loop Output Impedance vs Frequency                        | <a href="#">Figure 22</a>                             |
| Small-Signal Overshoot vs Capacitive Load (100-mV Output Step) | <a href="#">Figure 23</a> , <a href="#">Figure 24</a> |
| No Phase Reversal  | <a href="#">Figure 25</a>                             |
| Positive Overload Recovery                                     | <a href="#">Figure 26</a>                             |
| Negative Overload Recovery                                     | <a href="#">Figure 27</a>                             |
| Small-Signal Step Response (100 mV)                            | <a href="#">Figure 28</a> , <a href="#">Figure 29</a> |
| Large-Signal Step Response                                     | <a href="#">Figure 30</a> , <a href="#">Figure 31</a> |
| Large-Signal Settling Time (10-V Positive Step)                | <a href="#">Figure 32</a>                             |
| Large-Signal Settling Time (10-V Negative Step)                | <a href="#">Figure 33</a>                             |
| Short-Circuit Current vs Temperature                           | <a href="#">Figure 34</a>                             |
| Maximum Output Voltage vs Frequency                            | <a href="#">Figure 35</a>                             |
| Channel Separation vs Frequency                                | <a href="#">Figure 36</a>                             |

## 6.8 Typical Characteristics

$V_S = \pm 18\text{ V}$ ,  $V_{CM} = V_S / 2$ ,  $R_{LOAD} = 10\text{ k}\Omega$  connected to  $V_S / 2$ , and  $C_L = 100\text{ pF}$  (unless otherwise noted)

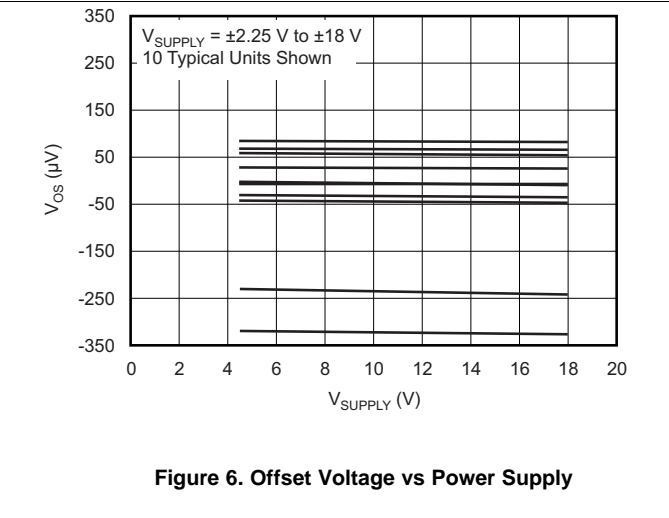
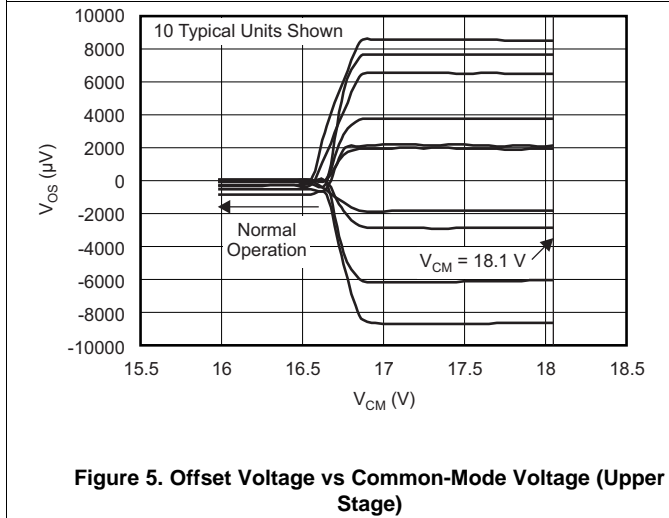
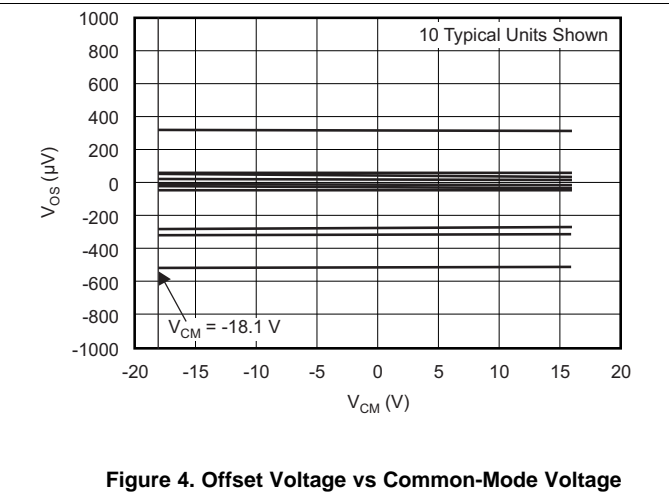
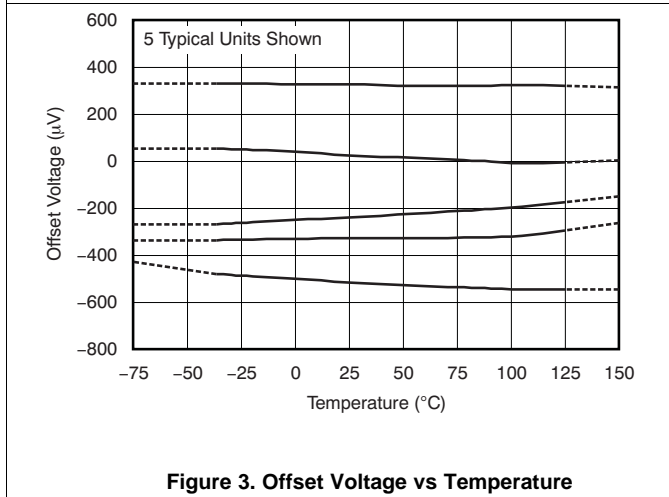
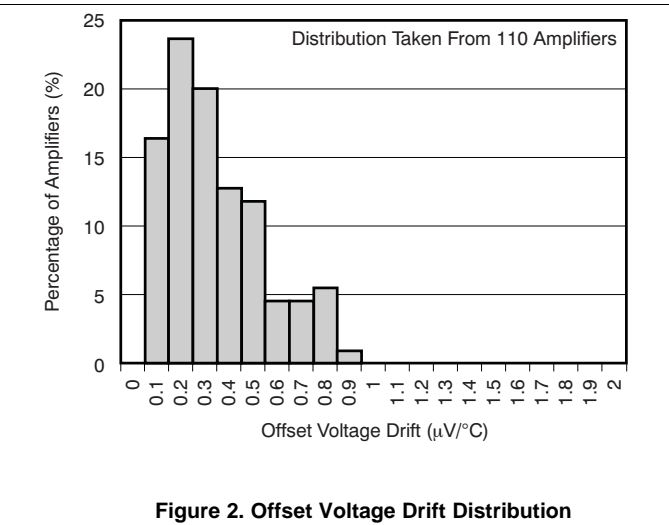
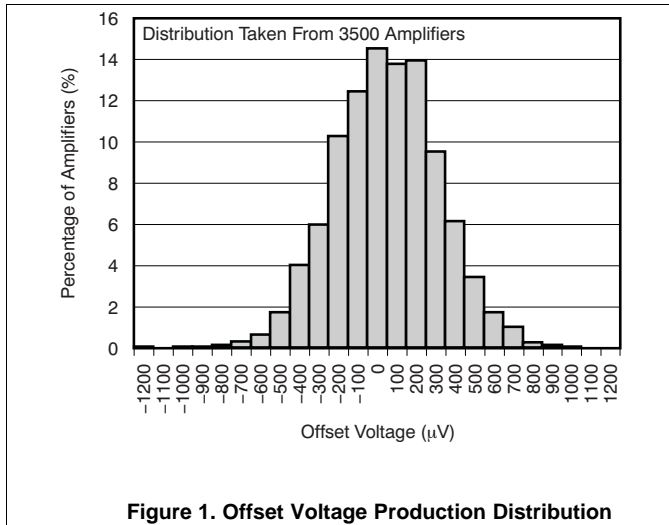

Typical Characteristics (continued)

$V_S = \pm 18\text{ V}$ ,  $V_{CM} = V_S / 2$ ,  $R_{LOAD} = 10\text{ k}\Omega$  connected to  $V_S / 2$ , and  $C_L = 100\text{ pF}$  (unless otherwise noted)

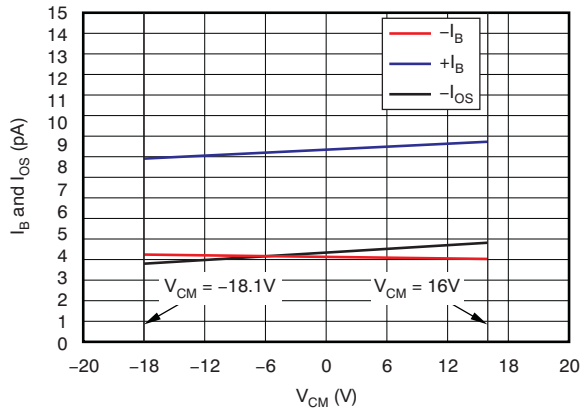

Figure 7.  $I_B$  and  $I_{OS}$  vs Common-Mode Voltage

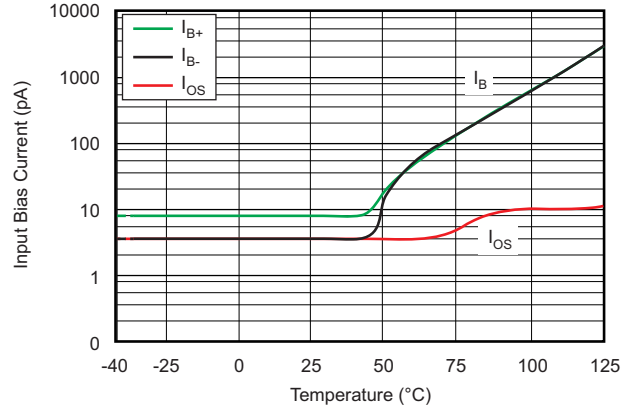

Figure 8. Input Bias Current vs Temperature

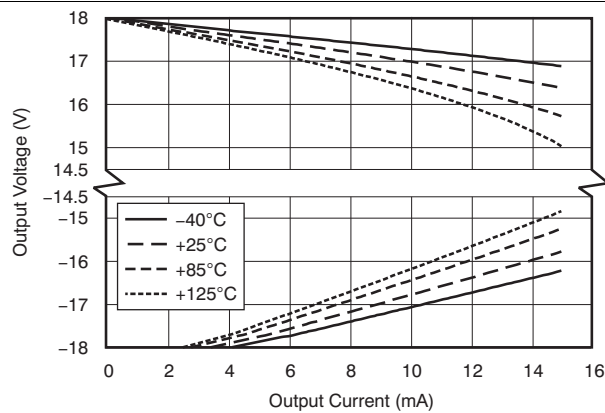

Figure 9. Output Voltage Swing vs Output Current (Maximum Supply)

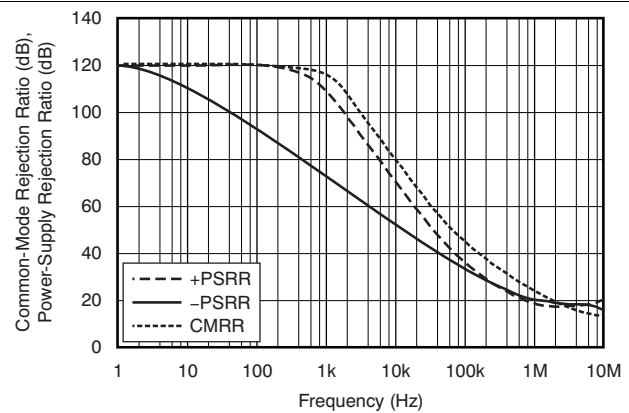

Figure 10. CMRR and PSRR vs Frequency (Referred-to Input)

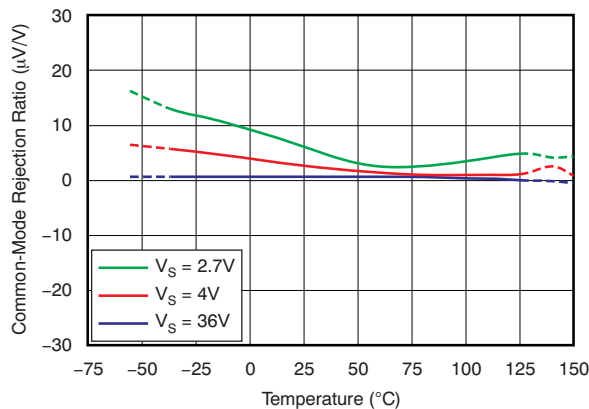

Figure 11. CMRR vs Temperature

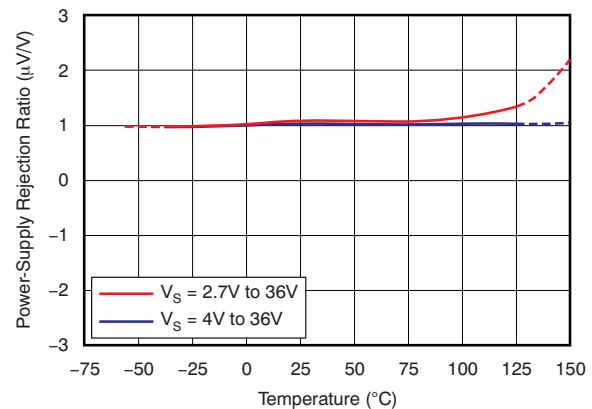

Figure 12. PSRR vs Temperature

Typical Characteristics (continued)

$V_S = \pm 18\text{ V}$ ,  $V_{CM} = V_S / 2$ ,  $R_{LOAD} = 10\text{ k}\Omega$  connected to  $V_S / 2$ , and  $C_L = 100\text{ pF}$  (unless otherwise noted)

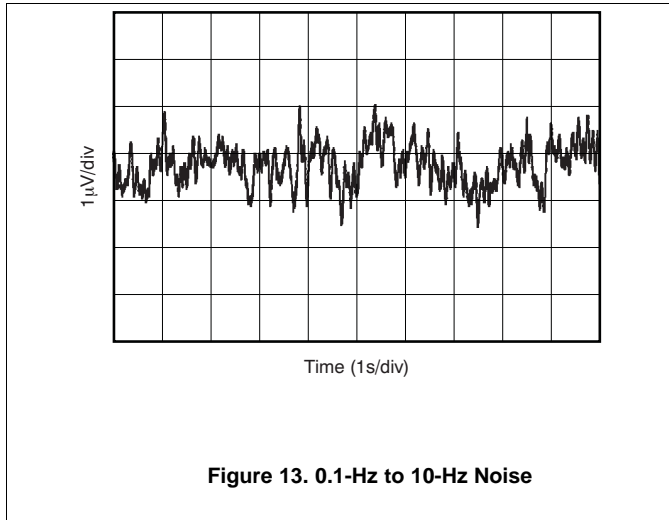

Figure 13. 0.1-Hz to 10-Hz Noise

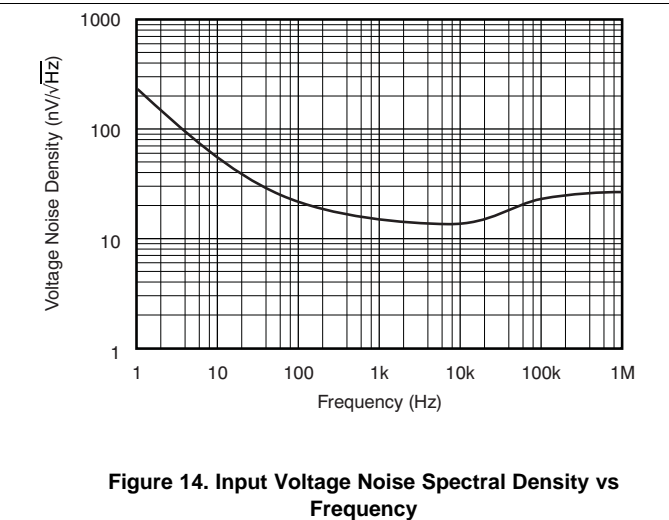

Figure 14. Input Voltage Noise Spectral Density vs Frequency

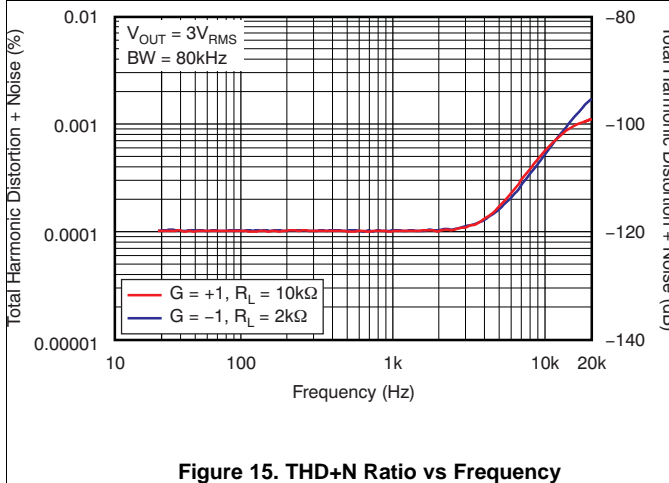

Figure 15. THD+N Ratio vs Frequency

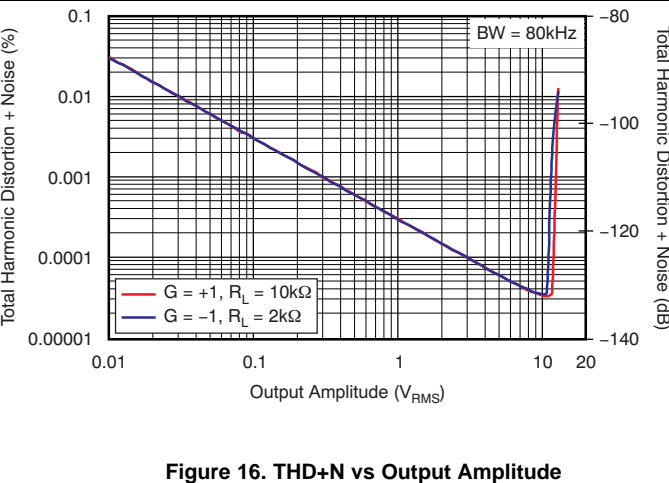

Figure 16. THD+N vs Output Amplitude

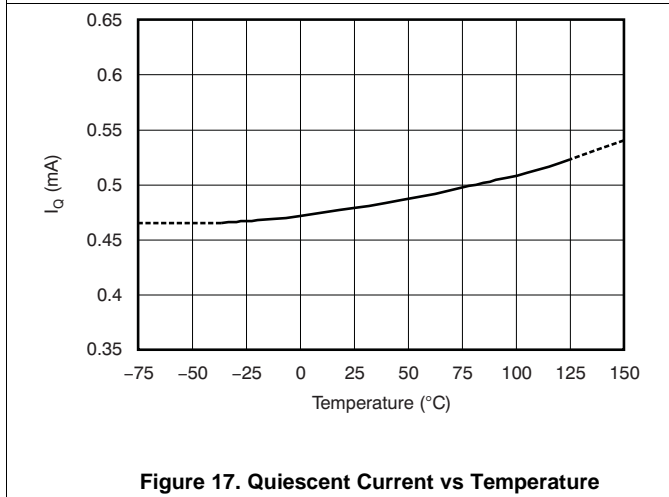

Figure 17. Quiescent Current vs Temperature

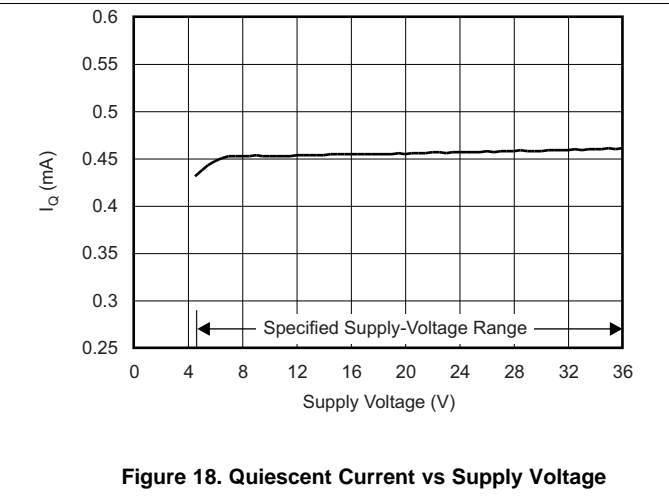

Figure 18. Quiescent Current vs Supply Voltage

Typical Characteristics (continued)

$V_S = \pm 18\text{ V}$ ,  $V_{CM} = V_S / 2$ ,  $R_{LOAD} = 10\text{ k}\Omega$  connected to  $V_S / 2$ , and  $C_L = 100\text{ pF}$  (unless otherwise noted)

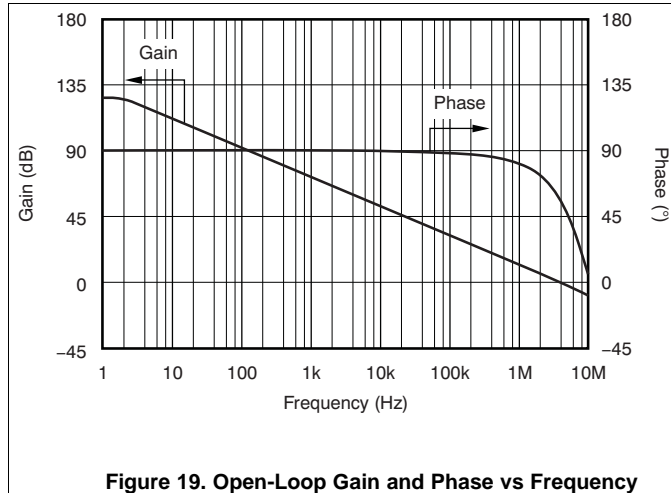

Figure 19. Open-Loop Gain and Phase vs Frequency

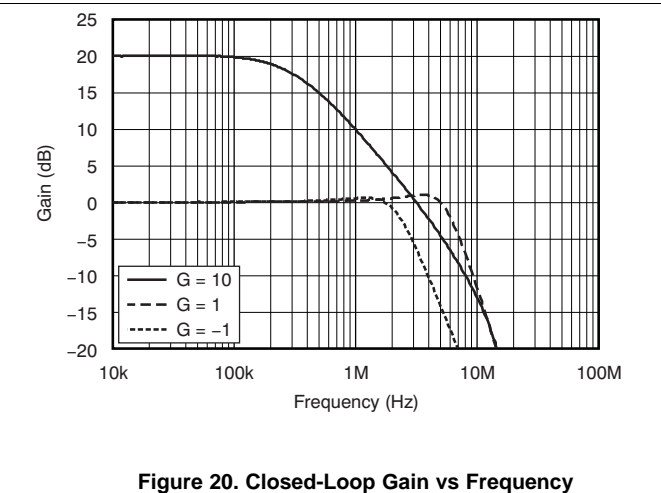

Figure 20. Closed-Loop Gain vs Frequency

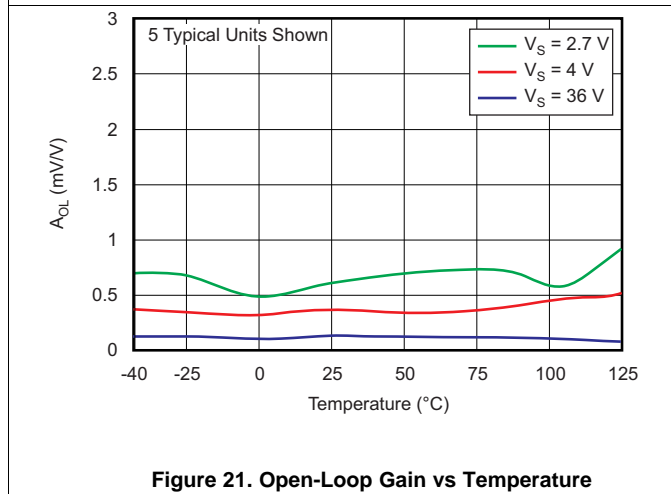

Figure 21. Open-Loop Gain vs Temperature

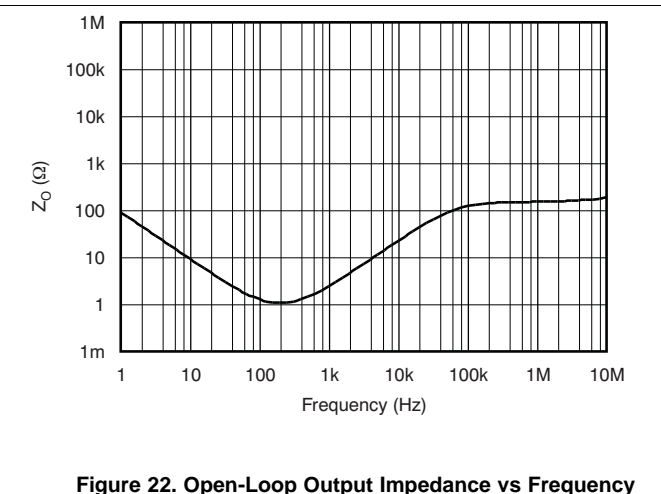

Figure 22. Open-Loop Output Impedance vs Frequency

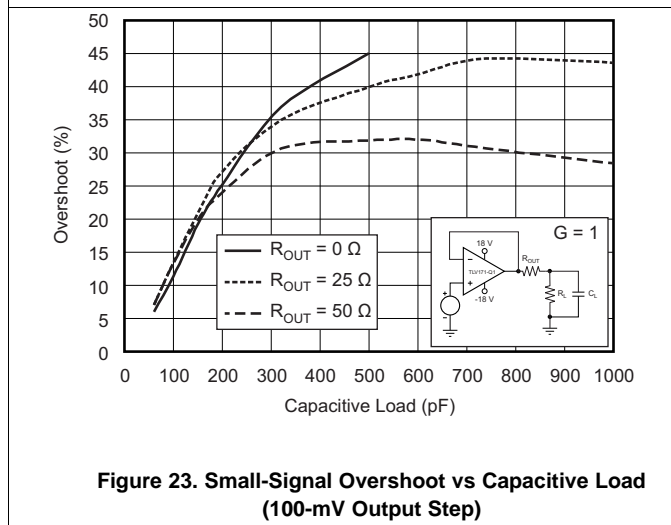

Figure 23. Small-Signal Overshoot vs Capacitive Load (100-mV Output Step)

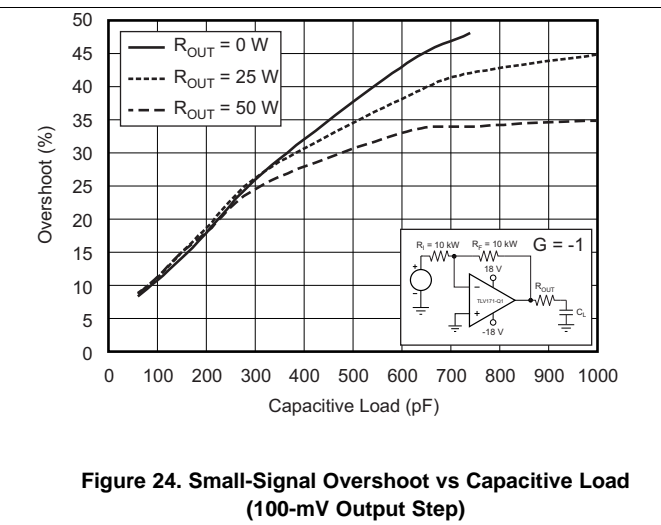
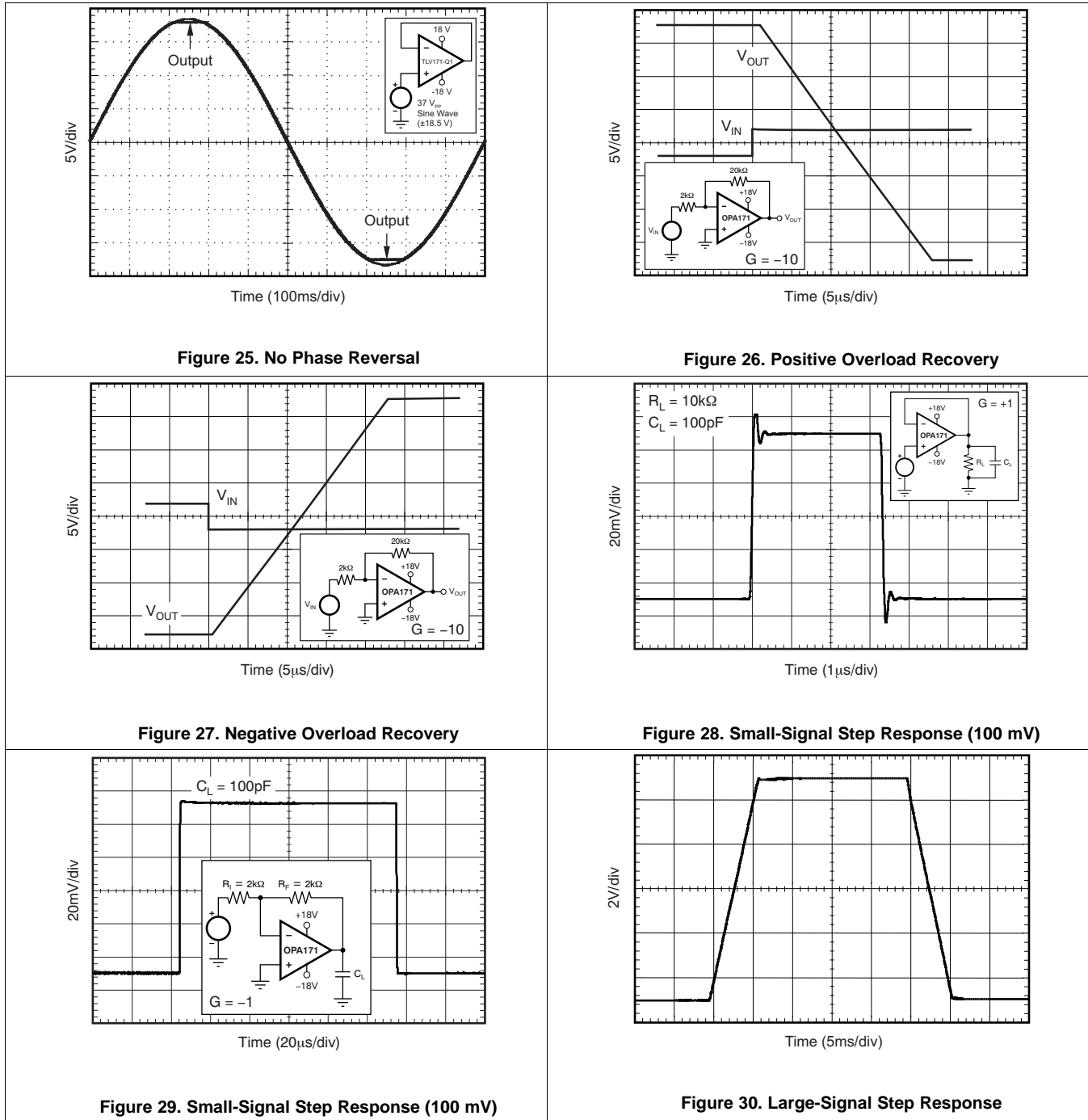

Figure 24. Small-Signal Overshoot vs Capacitive Load (100-mV Output Step)

Typical Characteristics (continued)

$V_S = \pm 18\text{ V}$ ,  $V_{CM} = V_S / 2$ ,  $R_{LOAD} = 10\text{ k}\Omega$  connected to  $V_S / 2$ , and  $C_L = 100\text{ pF}$  (unless otherwise noted)





Typical Characteristics (continued)

$V_S = \pm 18\text{ V}$ ,  $V_{CM} = V_S / 2$ ,  $R_{LOAD} = 10\text{ k}\Omega$  connected to  $V_S / 2$ , and  $C_L = 100\text{ pF}$  (unless otherwise noted)

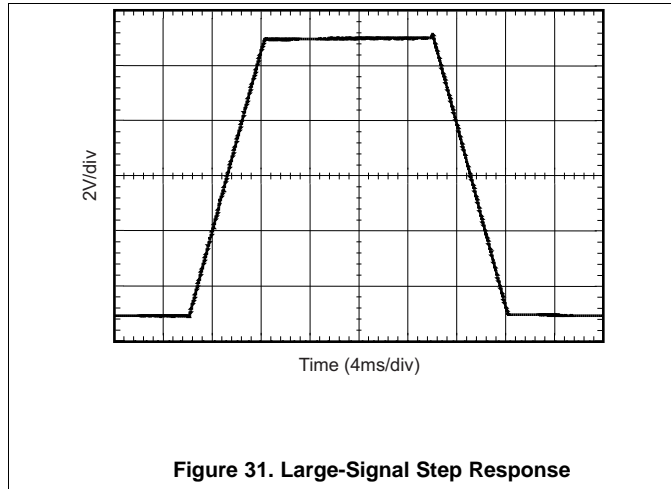

Figure 31. Large-Signal Step Response

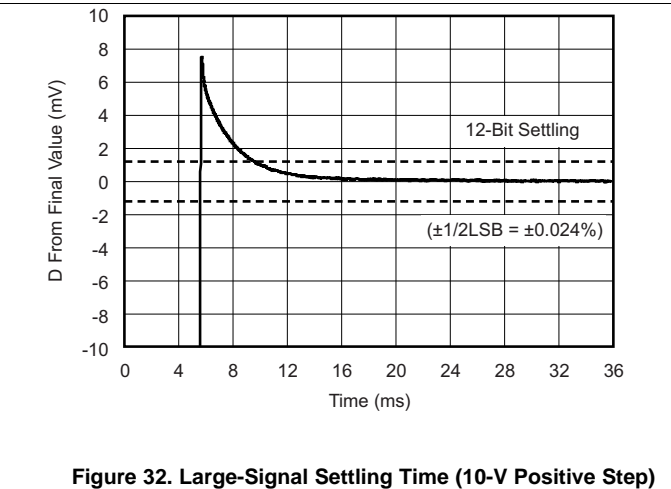

Figure 32. Large-Signal Settling Time (10-V Positive Step)

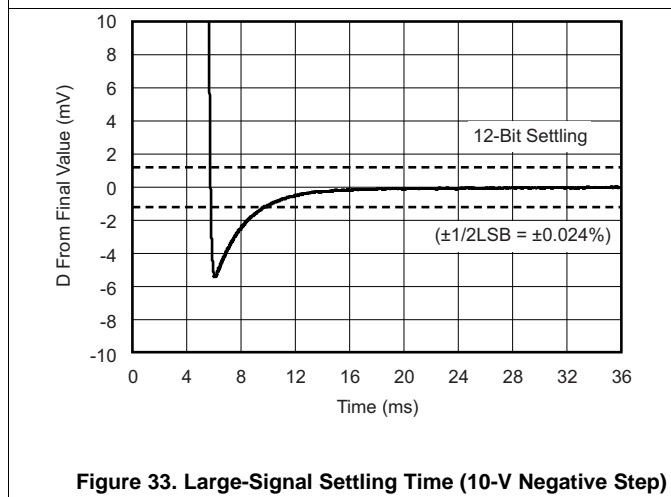

Figure 33. Large-Signal Settling Time (10-V Negative Step)

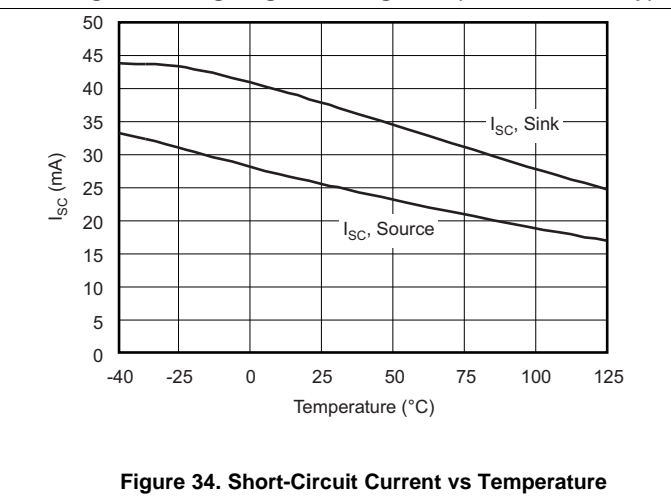

Figure 34. Short-Circuit Current vs Temperature

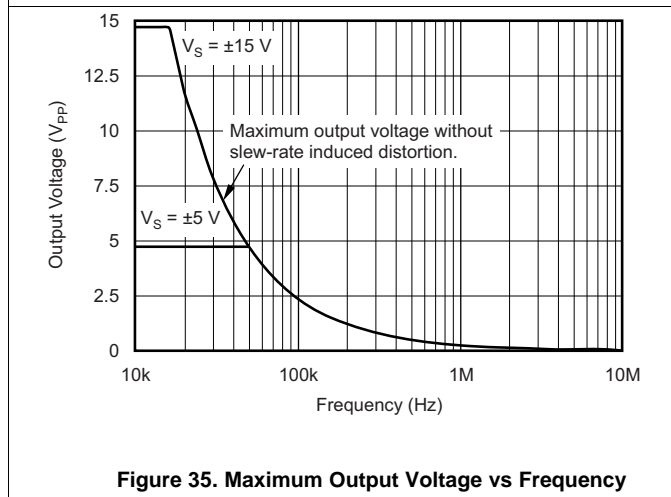

Figure 35. Maximum Output Voltage vs Frequency

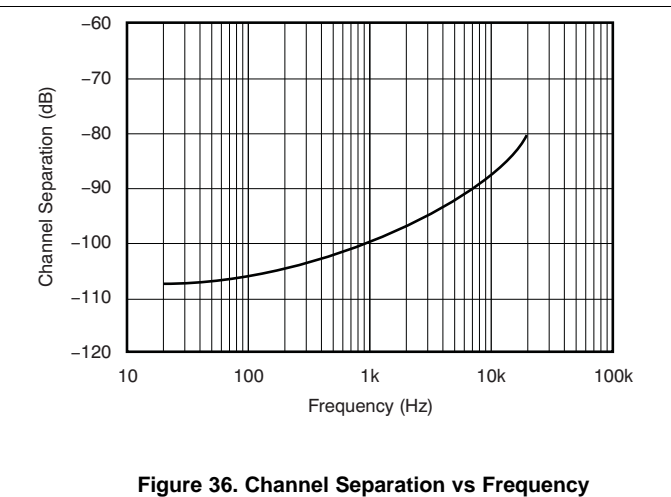

Figure 36. Channel Separation vs Frequency

## 7 Detailed Description

### 7.1 Overview

The OPAx171 operational amplifiers provide high overall performance, and are designed for many general-purpose applications. The excellent offset drift of only  $2 \mu\text{V}/^\circ\text{C}$  provides excellent stability over the entire temperature range. In addition, the series offers good overall performance with high CMRR, PSRR, and  $A_{OL}$ . As with all amplifiers, applications with noisy or high-impedance power supplies require decoupling capacitors close to the device pins. In most cases,  $0.1\text{-}\mu\text{F}$  capacitors are adequate.

### 7.2 Functional Block Diagram

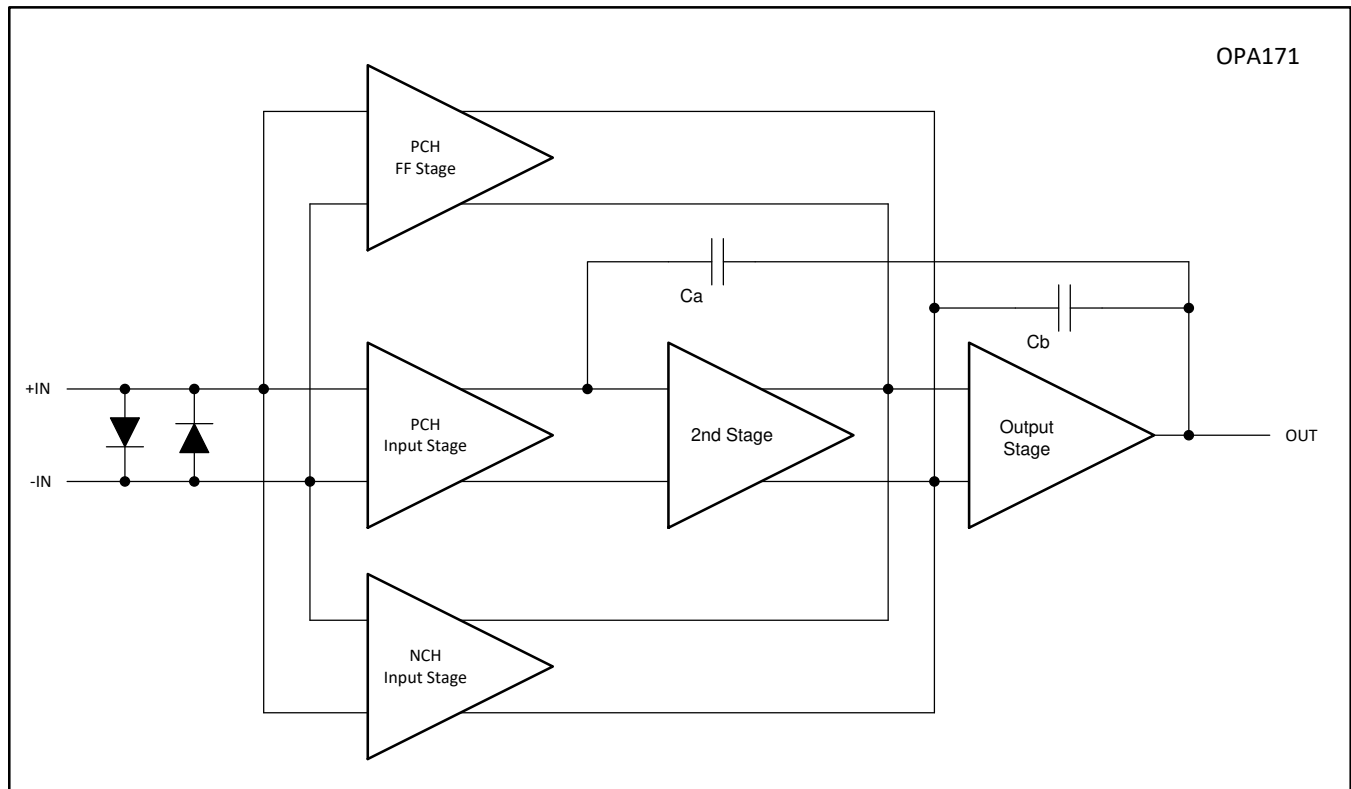

### 7.3 Feature Description

#### 7.3.1 Operating Characteristics

The OPAx171 family of amplifiers is specified for operation from 2.7 to 36 V ( $\pm 1.35$  to  $\pm 18$  V). Many of the specifications apply from  $-40^\circ\text{C}$  to  $+125^\circ\text{C}$ . Parameters that can exhibit significant variance with regard to operating voltage or temperature are presented in [Typical Characteristics](#).

#### 7.3.2 Common-Mode Voltage Range

The input common-mode voltage range of the OPAx171 series extends 100 mV below the negative rail and within 2 V of the top rail for normal operation.

This family can operate with full rail-to-rail input 100 mV beyond the top rail, but with reduced performance within 2 V of the top rail. The typical performance in this range is summarized in [Table 2](#).

## Feature Description (continued)

### 7.3.3 Phase-Reversal Protection

The OPAx171 family has an internal phase-reversal protection. Many operational amplifiers exhibit a phase reversal when the input is driven beyond its linear common-mode range. This condition is most often encountered in noninverting circuits when the input is driven beyond the specified common-mode voltage range, causing the output to reverse into the opposite rail. The input of the OPAx171 prevents phase reversal with excessive common-mode voltage. Instead, the output limits into the appropriate rail. This performance is shown in Figure 37.

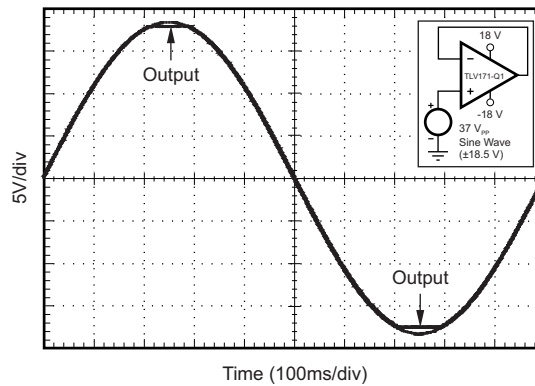

**Figure 37. No Phase Reversal**

**Table 2. Typical Performance Range**

| PARAMETER                 | MIN      | TYP | MAX        | UNIT   |
|---------------------------|----------|-----|------------|--------|
| Input common-mode voltage | (V+) – 2 |     | (V+) + 0.1 | V      |
| Offset voltage            |          | 7   |            | mV     |
| vs temperature            |          | 12  |            | μV/°C  |
| Common-mode rejection     |          | 65  |            | dB     |
| Open-loop gain            |          | 60  |            | dB     |
| GBW                       |          | 0.7 |            | MHz    |
| Slew rate                 |          | 0.7 |            | V/μs   |
| Noise at f = 1 kHz        |          | 30  |            | nV/√Hz |

### 7.3.4 Capacitive Load and Stability

The dynamic characteristics of the OPAx171-Q1 family of devices have been optimized for commonly encountered operating conditions. The combination of low closed-loop gain and high capacitive loads decreases the phase margin of the amplifier and can lead to gain peaking or oscillations. As a result, heavier capacitive loads must be isolated from the output. The simplest way to achieve this isolation is to add a small resistor (for example, R<sub>OUT</sub> equal to 50 Ω) in series with the output. Figure 38 and Figure 39 show small-signal overshoot versus capacitive load for several values of R<sub>OUT</sub>. For details of analysis techniques and application circuits, see [Applications Bulletin AB-028](#), available for download from [TI.com](#).

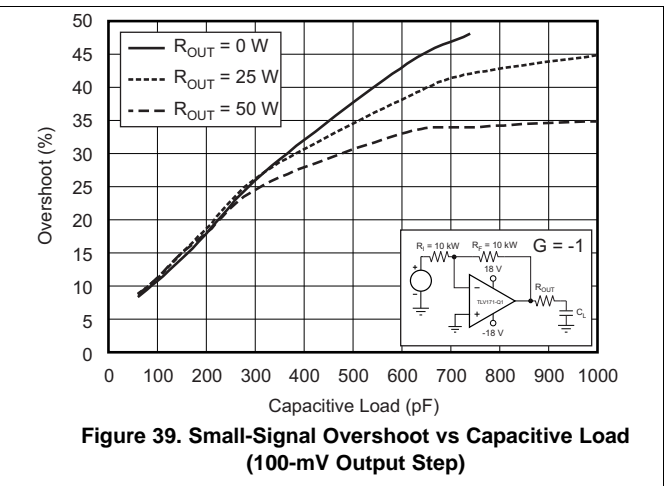
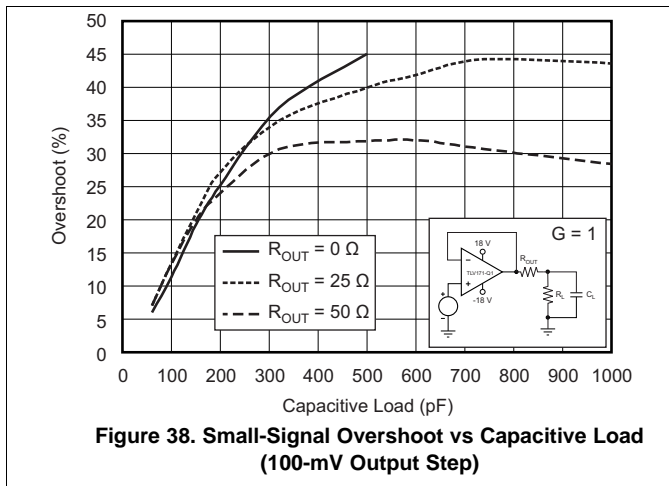

## 7.4 Device Functional Modes

### 7.4.1 Common-Mode Voltage Range

The input common-mode voltage range of the OPAx171 family extends 100 mV below the negative rail and within 2 V of the top rail for normal operation.

These devices can operate with full rail-to-rail input 100 mV beyond the top rail, but with reduced performance within 2 V of the top rail. The typical performance in this range is summarized in [Table 2](#).

## 8 Application and Implementation

### NOTE

Information in the following applications sections is not part of the TI component specification, and TI does not warrant its accuracy or completeness. TI's customers are responsible for determining suitability of components for their purposes. Customers should validate and test their design implementation to confirm system functionality.

### 8.1 Application Information

The OPAx171 operational amplifiers provide high overall performance, and are designed for many general-purpose applications. The excellent offset drift of only 2  $\mu\text{V}/^\circ\text{C}$  provides excellent stability over the entire temperature range. In addition, the series offers good overall performance with high CMRR, PSRR, and  $A_{\text{OL}}$ . As with all amplifiers, applications with noisy or high-impedance power supplies require decoupling capacitors close to the device pins. In most cases, 0.1- $\mu\text{F}$  capacitors are adequate.

#### 8.1.1 Electrical Overstress

Designers often ask questions about the capability of an operational amplifier to withstand electrical overstress. These questions tend to focus on the device inputs, but can involve the supply voltage pins or even the output pin. Each of these different pin functions have electrical stress limits determined by the voltage breakdown characteristics of the particular semiconductor fabrication process and specific circuits connected to the pin. Additionally, internal electrostatic discharge (ESD) protection is built into these circuits for protection from accidental ESD events both before and during product assembly.

A good understanding of this basic ESD circuitry and the relevance to an electrical overstress event is helpful. [Figure 40](#) shows the ESD circuits contained in the OPAx171 (indicated by the dashed line area). The ESD protection circuitry involves several current-steering diodes connected from the input and output pins and routed back to the internal power supply lines, where the diodes meet at an absorption device internal to the operational amplifier. This protection circuitry is intended to remain inactive during normal circuit operation.

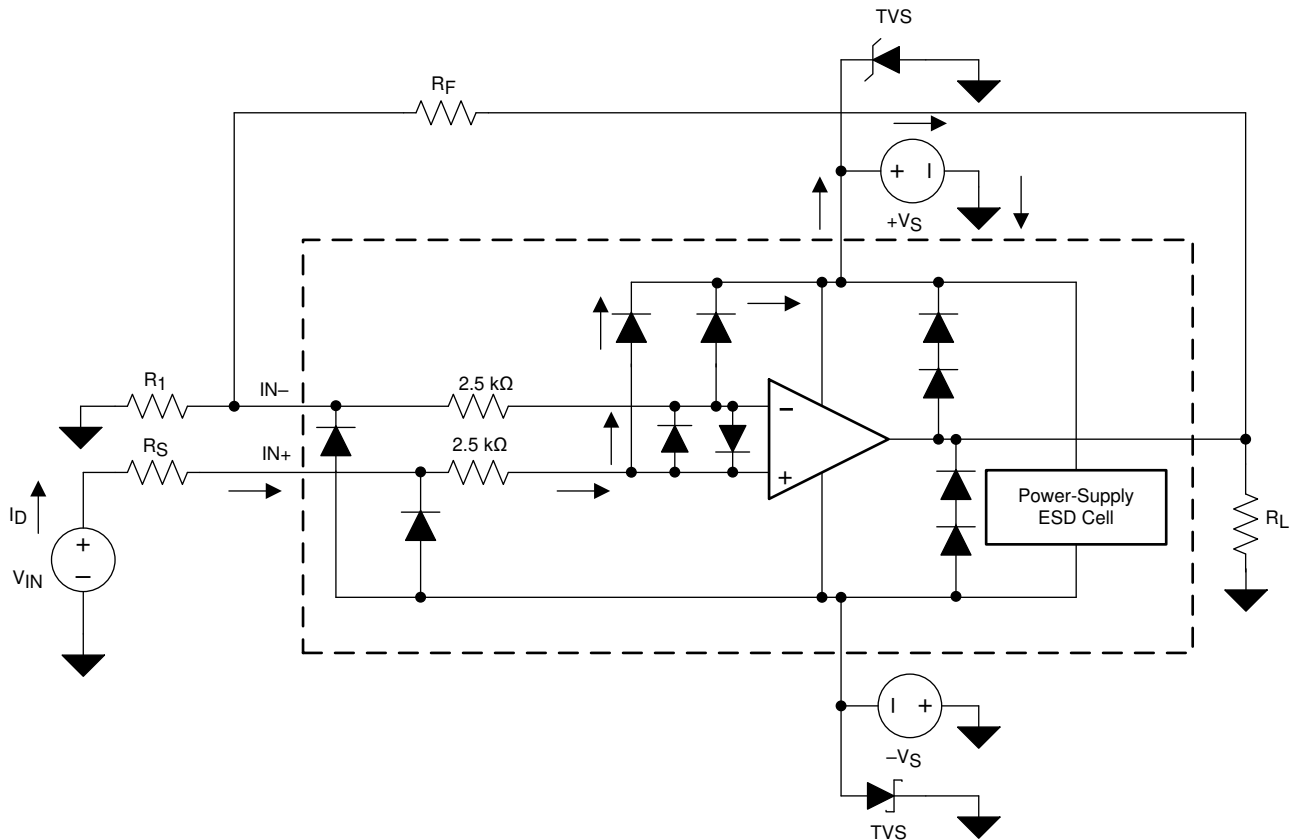
**Application Information (continued)**

**Figure 40. Equivalent Internal ESD Circuitry Relative to a Typical Circuit Application**

An ESD event produces a short duration, high-voltage pulse that is transformed into a short duration, high-current pulse when discharging through a semiconductor device. The ESD protection circuits are designed to provide a current path around the operational amplifier core to prevent damage. The energy absorbed by the protection circuitry is then dissipated as heat.

When an ESD voltage develops across two or more amplifier device pins, current flows through one or more steering diodes. Depending on the path that the current takes, the absorption device can activate. The absorption device contains a trigger (or threshold voltage) that is above the normal operating voltage of the OPAx171 but below the device breakdown level. When this threshold is exceeded, the absorption device quickly activates and clamps the voltage across the supply rails to a safe level.

When the operational amplifier connects into a circuit (as shown in [Figure 40](#)), the ESD protection components are intended to remain inactive and do not become involved in the application circuit operation. However, circumstances may arise when an applied voltage exceeds the operating voltage of a given pin. If this condition occurs, there is a risk that some internal ESD protection circuits can turn on and conduct current. Any such current flow occurs through steering-diode paths and rarely involves the absorption device.

[Figure 40](#) shows a specific example where the input voltage ( $V_{IN}$ ) exceeds the positive supply voltage ( $V+$ ) by 500 mV or more. Much of what happens in the circuit depends on the supply characteristics. If  $V+$  can sink the current, one of the upper steering diodes conducts and directs current to  $V+$ . Excessively high current levels can flow with increasingly higher  $V_{IN}$ . As a result, the data sheet specifications recommend that applications limit the input current to 10 mA.

If the supply is not capable of sinking the current,  $V_{IN}$  begins sourcing current to the operational amplifier and then take over as the source of positive supply voltage. The danger in this case is that the voltage can rise to levels that exceed the operational amplifier absolute maximum ratings.

## Application Information (continued)

Another common question involves what happens to the amplifier if an input signal is applied to the input when the power supplies ( $V_+$  or  $V_-$ ) are at 0 V. This question depends on the supply characteristic when at 0 V, or at a level below the input signal amplitude. If the supplies appear to be high-impedance, then the input source supplies the operational amplifier current through the current-steering diodes. This state is not a normal bias condition. Most likely, the amplifier does not operate normally. If the supplies are low-impedance, then the current through the steering diodes can be quite high. The current level depends on the ability of the input source to deliver current and any resistance in the input path.

If there is any uncertainty about the ability of the supply to absorb this current, add external Zener diodes to the supply pins; see [Figure 40](#). Select the Zener voltage so that the diode does not turn on during normal operation. However, the Zener voltage must be low enough so that the Zener diode conducts if the supply pin begins to rise above the safe operating, supply-voltage level.

The OPAX171 input pins are protected from excessive differential voltage with back-to-back diodes; see [Figure 40](#). In most circuit applications, the input protection circuitry does not affect the application. However, in low gain or  $G = 1$  circuits, fast-ramping input signals can forward bias these diodes because the output of the amplifier cannot respond rapidly enough to the input ramp. If the input signal is fast enough to create this forward-bias condition, limit the input signal current to 10 mA or less. If the input signal current is not inherently limited, an input series resistor can be used to limit the input signal current. This input series resistor degrades the low noise performance of the OPAX171. [Figure 40](#) shows an example configuration that implements a current-limiting feedback resistor.

## 8.2 Typical Application

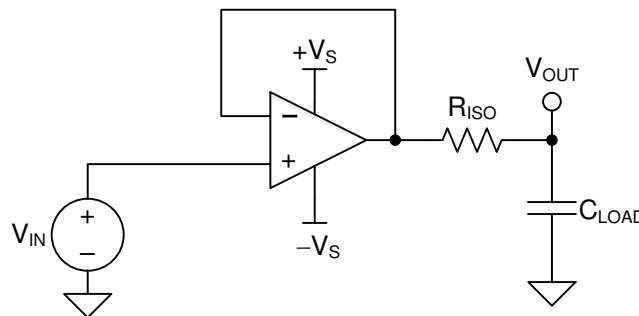

Figure 41. Unity-Gain Buffer With  $R_{ISO}$  Stability Compensation

### 8.2.1 Design Requirements

The design requirements are:

- Supply voltage: 30 V ( $\pm 15$  V)
- Capacitive loads: 100 pF, 1000 pF, 0.01  $\mu$ F, 0.1  $\mu$ F, and 1  $\mu$ F
- Phase margin: 45° and 60°

### 8.2.2 Detailed Design Procedure

[Figure 42](#) shows a unity-gain buffer driving a capacitive load. [Equation 1](#) shows the transfer function for the circuit in [Figure 42](#). Not shown in [Figure 42](#) is the open-loop output resistance of the operational amplifier,  $R_o$ .

$$T(s) = \frac{1 + C_{LOAD} \times R_{ISO} \times s}{1 + (R_o + R_{ISO}) \times C_{LOAD} \times s} \quad (1)$$

The transfer function in [Equation 1](#) contains a pole and a zero. The frequency of the pole ( $f_p$ ) is determined by  $(R_o + R_{ISO})$  and  $C_{LOAD}$ . Components  $R_{ISO}$  and  $C_{LOAD}$  determine the frequency of the zero ( $f_z$ ). Select  $R_{ISO}$  such that the rate of closure (ROC) between the open-loop gain ( $A_{OL}$ ) and  $1/\beta$  is 20 dB/decade to obtain a stable system. [Figure 42](#) shows the concept. The  $1/\beta$  curve for a unity-gain buffer is 0 dB.

Typical Application (continued)

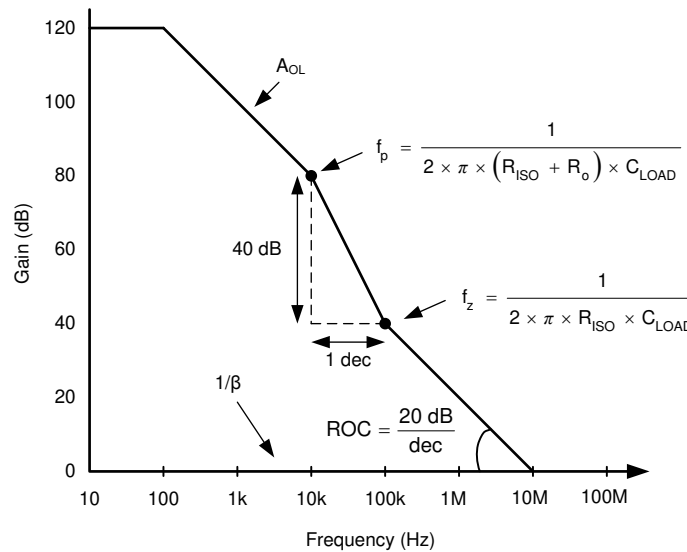

Figure 42. Unity-Gain Amplifier With R<sub>ISO</sub> Compensation

ROC stability analysis is typically simulated. The validity of the analysis depends on multiple factors, especially the accurate modeling of R<sub>o</sub>. In addition to simulating the ROC, a robust stability analysis includes a measurement of overshoot percentage and AC gain peaking of the circuit using a function generator, oscilloscope, and gain and phase analyzer. Phase margin is then calculated from these measurements. Table 3 shows the overshoot percentage and AC gain peaking that correspond to phase margins of 45° and 60°. For more details on this design and other alternative devices that can be used in place of the OPAx171, see [Capacitive Load Drive Solution using an Isolation Resistor](#).

Table 3. Phase Margin versus Overshoot and AC Gain Peaking

| PHASE MARGIN | OVERSHOOT | AC GAIN PEAKING |
|--------------|-----------|-----------------|
| 45°          | 23.3%     | 2.35 dB         |
| 60°          | 8.8%      | 0.28 dB         |

8.2.2.1 Capacitive Load and Stability

The dynamic characteristics of the OPAx171 are optimized for commonly encountered operating conditions. The combination of low closed-loop gain and high capacitive loads decreases the phase margin of the amplifier and can lead to gain peaking or oscillations. As a result, heavier capacitive loads must be isolated from the output. The simplest way to achieve this isolation is to add a small resistor (for example, R<sub>OUT</sub> equal to 50 Ω) in series with the output. Figure 38 and Figure 39 illustrate graphs of small-signal overshoot versus capacitive load for several values of R<sub>OUT</sub>. See [Applications Bulletin AB-028](#), available for download from the TI website for details of analysis techniques and application circuits.



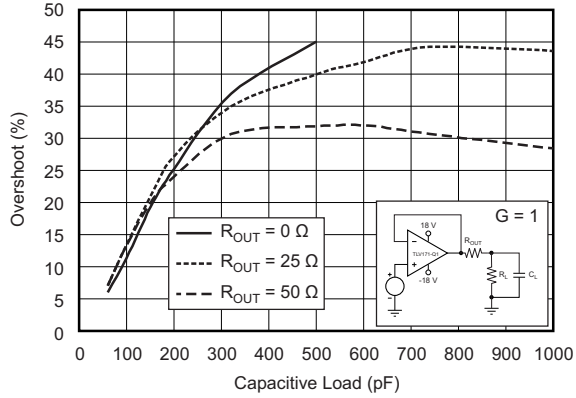

Figure 43. Small-Signal Overshoot vs Capacitive Load (100-mV Output Step)

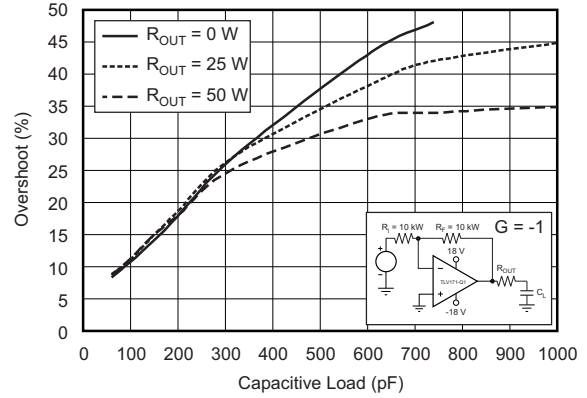
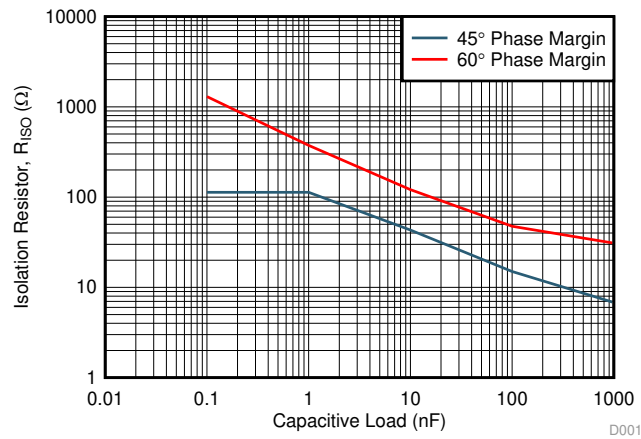

Figure 44. Small-Signal Overshoot vs Capacitive Load (100-mV Output Step)

### 8.2.3 Application Curve

The OPAx171 meets the supply voltage requirements of 30 V. The OPAx171 is tested for various capacitive loads and RISO is adjusted to get an overshoot corresponding to [Table 3](#). The results of these tests are summarized in [Figure 45](#).



**Figure 45. R<sub>ISO</sub> vs C<sub>LOAD</sub>**

## 9 Power Supply Recommendations

The OPAx171 family is specified for operation from 4.5 V to 36 V ( $\pm 2.25$  V to  $\pm 18$  V); many specifications apply from  $-40^{\circ}\text{C}$  to  $+125^{\circ}\text{C}$ . Parameters that can exhibit significant variance with regard to operating voltage or temperature are presented in the [Specifications](#) section.

### CAUTION

Supply voltages larger than 40 V can permanently damage the device; see the [Absolute Maximum Ratings](#) table.

Place 0.1- $\mu\text{F}$  bypass capacitors close to the power-supply pins to reduce errors coupling in from noisy or high-impedance power supplies. For detailed information on bypass capacitor placement, see the [Layout Guidelines](#) section.

## 10 Layout

### 10.1 Layout Guidelines

For best operational performance of the devices, good printed circuit board (PCB) layout practices are recommended. Low-loss, 0.1- $\mu\text{F}$  bypass capacitors must be connected between each supply pin and ground, placed as close to the devices as possible. A single bypass capacitor from V+ to ground is applicable to single-supply applications.

### 10.2 Layout Example

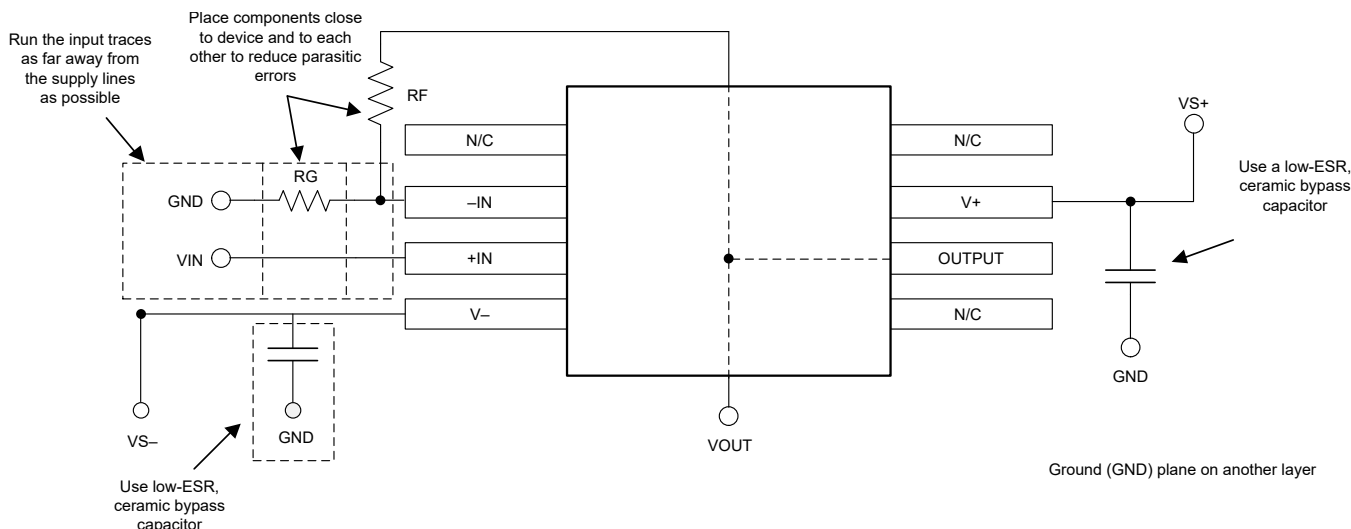

Copyright © 2019, Texas Instruments Incorporated

Figure 46. Operational Amplifier Board Layout for Noninverting Configuration

## 11 Device and Documentation Support

### 11.1 Related Links

The table below lists quick access links. Categories include technical documents, support and community resources, tools and software, and quick access to sample or buy.

**Table 4. Related Links**

| PARTS   | PRODUCT FOLDER             | ORDER NOW                  | TECHNICAL DOCUMENTS        | TOOLS & SOFTWARE           | SUPPORT & COMMUNITY        |
|---------|----------------------------|----------------------------|----------------------------|----------------------------|----------------------------|
| OPA171  | <a href="#">Click here</a> | <a href="#">Click here</a> | <a href="#">Click here</a> | <a href="#">Click here</a> | <a href="#">Click here</a> |
| OPA2171 | <a href="#">Click here</a> | <a href="#">Click here</a> | <a href="#">Click here</a> | <a href="#">Click here</a> | <a href="#">Click here</a> |
| OPA4171 | <a href="#">Click here</a> | <a href="#">Click here</a> | <a href="#">Click here</a> | <a href="#">Click here</a> | <a href="#">Click here</a> |

### 11.2 Support Resources

[TI E2E™ support forums](#) are an engineer's go-to source for fast, verified answers and design help — straight from the experts. Search existing answers or ask your own question to get the quick design help you need.

Linked content is provided "AS IS" by the respective contributors. They do not constitute TI specifications and do not necessarily reflect TI's views; see TI's [Terms of Use](#).

### 11.3 Trademarks

E2E is a trademark of Texas Instruments.

All other trademarks are the property of their respective owners.

### 11.4 Electrostatic Discharge Caution



These devices have limited built-in ESD protection. The leads should be shorted together or the device placed in conductive foam during storage or handling to prevent electrostatic damage to the MOS gates.

### 11.5 Glossary

[SLYZ022](#) — *TI Glossary*.

This glossary lists and explains terms, acronyms, and definitions.

## 12 Mechanical, Packaging, and Orderable Information

The following pages include mechanical, packaging, and orderable information. This information is the most current data available for the designated devices. This data is subject to change without notice and revision of this document. For browser-based versions of this data sheet, refer to the left-hand navigation.

**PACKAGING INFORMATION**

| Orderable Device | Status<br>(1) | Package Type | Package Drawing | Pins | Package Qty | Eco Plan<br>(2) | Lead finish/<br>Ball material<br>(6) | MSL Peak Temp<br>(3) | Op Temp (°C) | Device Marking<br>(4/5) | Samples                 |
|------------------|---------------|--------------|-----------------|------|-------------|-----------------|--------------------------------------|----------------------|--------------|-------------------------|-------------------------|
| OPA171AID        | ACTIVE        | SOIC         | D               | 8    | 75          | RoHS & Green    | NIPDAU                               | Level-2-260C-1 YEAR  | -40 to 125   | O171A                   | <a href="#">Samples</a> |
| OPA171AIDBVR     | ACTIVE        | SOT-23       | DBV             | 5    | 3000        | RoHS & Green    | NIPDAU                               | Level-2-260C-1 YEAR  | -40 to 125   | OSUI                    | <a href="#">Samples</a> |
| OPA171AIDBVT     | ACTIVE        | SOT-23       | DBV             | 5    | 250         | RoHS & Green    | NIPDAU                               | Level-2-260C-1 YEAR  | -40 to 125   | OSUI                    | <a href="#">Samples</a> |
| OPA171AIDR       | ACTIVE        | SOIC         | D               | 8    | 2500        | RoHS & Green    | NIPDAU                               | Level-2-260C-1 YEAR  | -40 to 125   | O171A                   | <a href="#">Samples</a> |
| OPA171AIDRLR     | ACTIVE        | SOT-5X3      | DRL             | 5    | 4000        | RoHS & Green    | NIPDAUAG                             | Level-1-260C-UNLIM   | -40 to 125   | DAP                     | <a href="#">Samples</a> |
| OPA171AIDRLT     | ACTIVE        | SOT-5X3      | DRL             | 5    | 250         | RoHS & Green    | NIPDAUAG                             | Level-1-260C-UNLIM   | -40 to 125   | DAP                     | <a href="#">Samples</a> |
| OPA2171AID       | ACTIVE        | SOIC         | D               | 8    | 75          | RoHS & Green    | NIPDAU                               | Level-2-260C-1 YEAR  | -40 to 125   | 2171A                   | <a href="#">Samples</a> |
| OPA2171AIDCUR    | ACTIVE        | VSSOP        | DCU             | 8    | 3000        | RoHS & Green    | NIPDAU                               | Level-1-260C-UNLIM   | -40 to 125   | OPOC                    | <a href="#">Samples</a> |
| OPA2171AIDCUT    | ACTIVE        | VSSOP        | DCU             | 8    | 250         | RoHS & Green    | NIPDAU                               | Level-1-260C-UNLIM   | -40 to 125   | OPOC                    | <a href="#">Samples</a> |
| OPA2171AIDGK     | ACTIVE        | VSSOP        | DGK             | 8    | 80          | RoHS & Green    | NIPDAUAG                             | Level-2-260C-1 YEAR  | -40 to 125   | OPMI                    | <a href="#">Samples</a> |
| OPA2171AIDGKR    | ACTIVE        | VSSOP        | DGK             | 8    | 2500        | RoHS & Green    | NIPDAUAG   SN                        | Level-2-260C-1 YEAR  | -40 to 125   | OPMI                    | <a href="#">Samples</a> |
| OPA2171AIDR      | ACTIVE        | SOIC         | D               | 8    | 2500        | RoHS & Green    | NIPDAU                               | Level-2-260C-1 YEAR  | -40 to 125   | 2171A                   | <a href="#">Samples</a> |
| OPA4171AID       | ACTIVE        | SOIC         | D               | 14   | 50          | RoHS & Green    | NIPDAU                               | Level-3-260C-168 HR  | -40 to 125   | OPA4171                 | <a href="#">Samples</a> |
| OPA4171AIDR      | ACTIVE        | SOIC         | D               | 14   | 2500        | RoHS & Green    | NIPDAU                               | Level-3-260C-168 HR  | -40 to 125   | OPA4171                 | <a href="#">Samples</a> |
| OPA4171AIPW      | ACTIVE        | TSSOP        | PW              | 14   | 90          | RoHS & Green    | NIPDAU                               | Level-2-260C-1 YEAR  | -40 to 125   | OPA4171                 | <a href="#">Samples</a> |
| OPA4171AIPWR     | ACTIVE        | TSSOP        | PW              | 14   | 2000        | RoHS & Green    | NIPDAU                               | Level-2-260C-1 YEAR  | -40 to 125   | OPA4171                 | <a href="#">Samples</a> |

(1) The marketing status values are defined as follows:

**ACTIVE:** Product device recommended for new designs.

**LIFEBUY:** TI has announced that the device will be discontinued, and a lifetime-buy period is in effect.

**NRND:** Not recommended for new designs. Device is in production to support existing customers, but TI does not recommend using this part in a new design.

**PREVIEW:** Device has been announced but is not in production. Samples may or may not be available.

**OBSELETE:** TI has discontinued the production of the device.

(2) **RoHS:** TI defines "RoHS" to mean semiconductor products that are compliant with the current EU RoHS requirements for all 10 RoHS substances, including the requirement that RoHS substance do not exceed 0.1% by weight in homogeneous materials. Where designed to be soldered at high temperatures, "RoHS" products are suitable for use in specified lead-free processes. TI may reference these types of products as "Pb-Free".

**RoHS Exempt:** TI defines "RoHS Exempt" to mean products that contain lead but are compliant with EU RoHS pursuant to a specific EU RoHS exemption.

**Green:** TI defines "Green" to mean the content of Chlorine (Cl) and Bromine (Br) based flame retardants meet JS709B low halogen requirements of  $\leq 1000$ ppm threshold. Antimony trioxide based flame retardants must also meet the  $\leq 1000$ ppm threshold requirement.

(3) MSL, Peak Temp. - The Moisture Sensitivity Level rating according to the JEDEC industry standard classifications, and peak solder temperature.

(4) There may be additional marking, which relates to the logo, the lot trace code information, or the environmental category on the device.

(5) Multiple Device Markings will be inside parentheses. Only one Device Marking contained in parentheses and separated by a "~" will appear on a device. If a line is indented then it is a continuation of the previous line and the two combined represent the entire Device Marking for that device.

(6) Lead finish/Ball material - Orderable Devices may have multiple material finish options. Finish options are separated by a vertical ruled line. Lead finish/Ball material values may wrap to two lines if the finish value exceeds the maximum column width.

**Important Information and Disclaimer:** The information provided on this page represents TI's knowledge and belief as of the date that it is provided. TI bases its knowledge and belief on information provided by third parties, and makes no representation or warranty as to the accuracy of such information. Efforts are underway to better integrate information from third parties. TI has taken and continues to take reasonable steps to provide representative and accurate information but may not have conducted destructive testing or chemical analysis on incoming materials and chemicals. TI and TI suppliers consider certain information to be proprietary, and thus CAS numbers and other limited information may not be available for release.

In no event shall TI's liability arising out of such information exceed the total purchase price of the TI part(s) at issue in this document sold by TI to Customer on an annual basis.

**OTHER QUALIFIED VERSIONS OF OPA171, OPA2171, OPA4171 :**

● Automotive : [OPA171-Q1](#), [OPA2171-Q1](#), [OPA4171-Q1](#)

● Enhanced Product : [OPA2171-EP](#)

NOTE: Qualified Version Definitions:

● Automotive - Q100 devices qualified for high-reliability automotive applications targeting zero defects

● Enhanced Product - Supports Defense, Aerospace and Medical Applications

**TAPE AND REEL INFORMATION**

**QUADRANT ASSIGNMENTS FOR PIN 1 ORIENTATION IN TAPE**

\*All dimensions are nominal

| Device        | Package Type | Package Drawing | Pins | SPQ  | Reel Diameter (mm) | Reel Width W1 (mm) | A0 (mm) | B0 (mm) | K0 (mm) | P1 (mm) | W (mm) | Pin1 Quadrant |
|---------------|--------------|-----------------|------|------|--------------------|--------------------|---------|---------|---------|---------|--------|---------------|
| OPA171AIDBVR  | SOT-23       | DBV             | 5    | 3000 | 180.0              | 8.4                | 3.23    | 3.17    | 1.37    | 4.0     | 8.0    | Q3            |
| OPA171AIDBVR  | SOT-23       | DBV             | 5    | 3000 | 179.0              | 8.4                | 3.2     | 3.2     | 1.4     | 4.0     | 8.0    | Q3            |
| OPA171AIDBVT  | SOT-23       | DBV             | 5    | 250  | 179.0              | 8.4                | 3.2     | 3.2     | 1.4     | 4.0     | 8.0    | Q3            |
| OPA171AIDBVT  | SOT-23       | DBV             | 5    | 250  | 180.0              | 8.4                | 3.23    | 3.17    | 1.37    | 4.0     | 8.0    | Q3            |
| OPA171AIDR    | SOIC         | D               | 8    | 2500 | 330.0              | 12.4               | 6.4     | 5.2     | 2.1     | 8.0     | 12.0   | Q1            |
| OPA171AIDRLR  | SOT-5X3      | DRL             | 5    | 4000 | 180.0              | 8.4                | 1.98    | 1.78    | 0.69    | 4.0     | 8.0    | Q3            |
| OPA171AIDRLT  | SOT-5X3      | DRL             | 5    | 250  | 180.0              | 8.4                | 1.98    | 1.78    | 0.69    | 4.0     | 8.0    | Q3            |
| OPA2171AIDCUR | VSSOP        | DCU             | 8    | 3000 | 180.0              | 8.4                | 2.25    | 3.35    | 1.05    | 4.0     | 8.0    | Q3            |
| OPA2171AIDCUT | VSSOP        | DCU             | 8    | 250  | 180.0              | 8.4                | 2.25    | 3.35    | 1.05    | 4.0     | 8.0    | Q3            |
| OPA2171AIDGKR | VSSOP        | DGK             | 8    | 2500 | 330.0              | 12.4               | 5.3     | 3.4     | 1.4     | 8.0     | 12.0   | Q1            |
| OPA2171AIDR   | SOIC         | D               | 8    | 2500 | 330.0              | 12.4               | 6.4     | 5.2     | 2.1     | 8.0     | 12.0   | Q1            |
| OPA4171AIDR   | SOIC         | D               | 14   | 2500 | 330.0              | 16.4               | 6.5     | 9.0     | 2.1     | 8.0     | 16.0   | Q1            |
| OPA4171AIPWR  | TSSOP        | PW              | 14   | 2000 | 330.0              | 12.4               | 6.9     | 5.6     | 1.6     | 8.0     | 12.0   | Q1            |

**TAPE AND REEL BOX DIMENSIONS**

\*All dimensions are nominal

| Device        | Package Type | Package Drawing | Pins | SPQ  | Length (mm) | Width (mm) | Height (mm) |
|---------------|--------------|-----------------|------|------|-------------|------------|-------------|
| OPA171AIDBVR  | SOT-23       | DBV             | 5    | 3000 | 213.0       | 191.0      | 35.0        |
| OPA171AIDBVR  | SOT-23       | DBV             | 5    | 3000 | 195.0       | 200.0      | 45.0        |
| OPA171AIDBVT  | SOT-23       | DBV             | 5    | 250  | 213.0       | 191.0      | 35.0        |
| OPA171AIDBVT  | SOT-23       | DBV             | 5    | 250  | 223.0       | 270.0      | 35.0        |
| OPA171AIDR    | SOIC         | D               | 8    | 2500 | 356.0       | 356.0      | 35.0        |
| OPA171AIDRLR  | SOT-5X3      | DRL             | 5    | 4000 | 202.0       | 201.0      | 28.0        |
| OPA171AIDRLT  | SOT-5X3      | DRL             | 5    | 250  | 202.0       | 201.0      | 28.0        |
| OPA2171AIDCUR | VSSOP        | DCU             | 8    | 3000 | 202.0       | 201.0      | 28.0        |
| OPA2171AIDCUT | VSSOP        | DCU             | 8    | 250  | 202.0       | 201.0      | 28.0        |
| OPA2171AIDGKR | VSSOP        | DGK             | 8    | 2500 | 366.0       | 364.0      | 50.0        |
| OPA2171AIDR   | SOIC         | D               | 8    | 2500 | 356.0       | 356.0      | 35.0        |
| OPA4171AIDR   | SOIC         | D               | 14   | 2500 | 356.0       | 356.0      | 35.0        |
| OPA4171AIPWR  | TSSOP        | PW              | 14   | 2000 | 356.0       | 356.0      | 35.0        |



**TUBE**

\*All dimensions are nominal

| Device       | Package Name | Package Type | Pins | SPQ | L (mm) | W (mm) | T (μm) | B (mm) |
|--------------|--------------|--------------|------|-----|--------|--------|--------|--------|
| OPA171AID    | D            | SOIC         | 8    | 75  | 506.6  | 8      | 3940   | 4.32   |
| OPA2171AID   | D            | SOIC         | 8    | 75  | 506.6  | 8      | 3940   | 4.32   |
| OPA2171AIDGK | DGK          | VSSOP        | 8    | 80  | 330    | 6.55   | 500    | 2.88   |
| OPA4171AID   | D            | SOIC         | 14   | 50  | 506.6  | 8      | 3940   | 4.32   |
| OPA4171AIPW  | PW           | TSSOP        | 14   | 90  | 530    | 10.2   | 3600   | 3.5    |



4225266/A 09/2014

NOTES:

1. All linear dimensions are in millimeters. Any dimensions in parenthesis are for reference only. Dimensioning and tolerancing per ASME Y14.5M.
2. This drawing is subject to change without notice.
3. This dimension does not include mold flash, protrusions, or gate burrs. Mold flash, protrusions, or gate burrs shall not exceed 0.15 mm per side.
4. Reference JEDEC registration MO-187 variation CA.

# EXAMPLE BOARD LAYOUT

DCU0008A

VSSOP - 0.9 mm max height

SMALL OUTLINE PACKAGE



LAND PATTERN EXAMPLE  
EXPOSED METAL SHOWN  
SCALE: 25X



4225266/A 09/2014

NOTES: (continued)

- 5. Publication IPC-7351 may have alternate designs.
- 6. Solder mask tolerances between and around signal pads can vary based on board fabrication site.

# EXAMPLE STENCIL DESIGN

DCU0008A

VSSOP - 0.9 mm max height

SMALL OUTLINE PACKAGE



SOLDER PASTE EXAMPLE  
BASED ON 0.125 mm THICK STENCIL  
SCALE: 25X

4225266/A 09/2014

NOTES: (continued)

7. Laser cutting apertures with trapezoidal walls and rounded corners may offer better paste release. IPC-7525 may have alternate design recommendations.
8. Board assembly site may have different recommendations for stencil design.

# DBV0005A



# PACKAGE OUTLINE

SOT-23 - 1.45 mm max height

SMALL OUTLINE TRANSISTOR

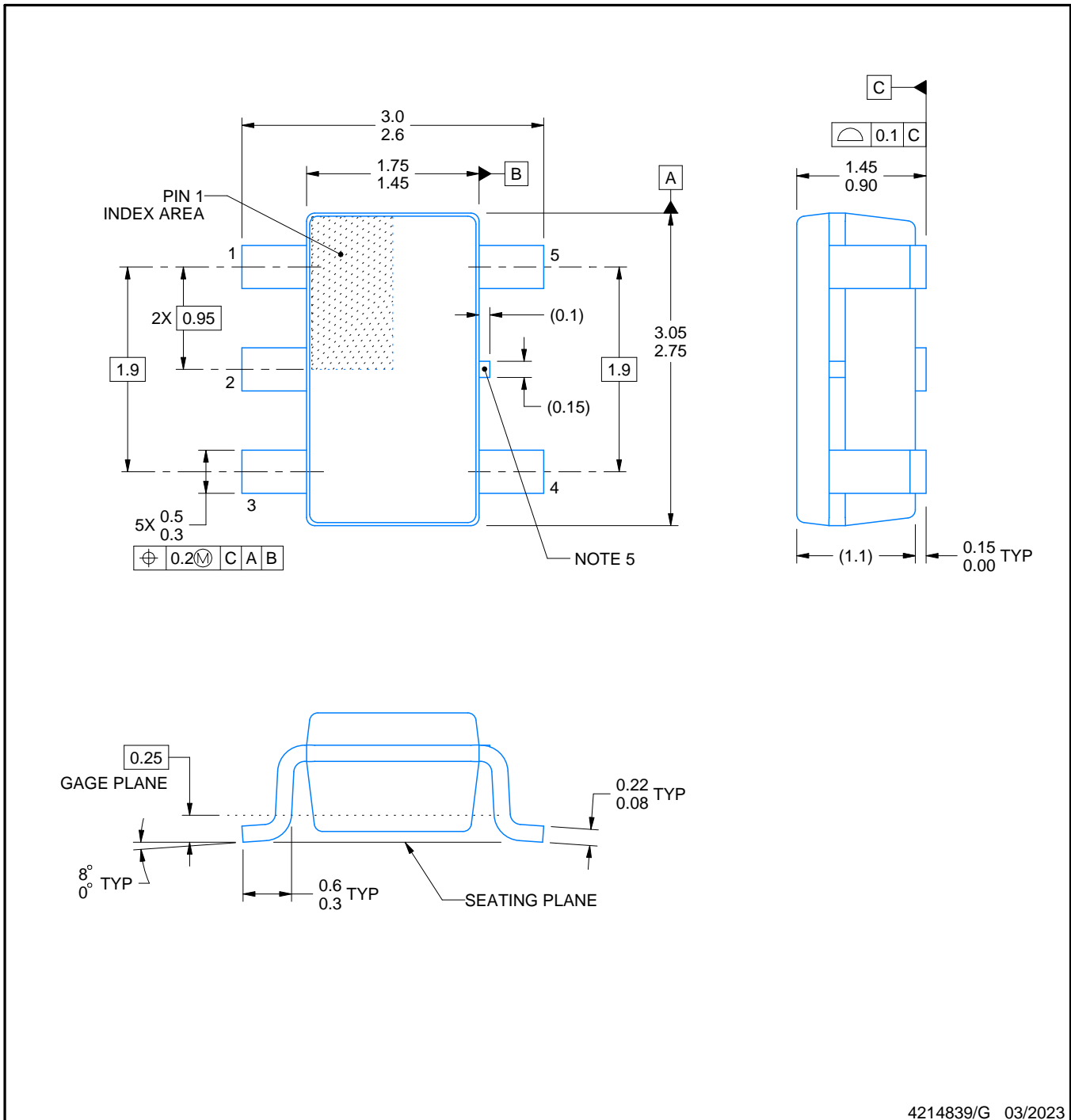

4214839/G 03/2023

### NOTES:

1. All linear dimensions are in millimeters. Any dimensions in parenthesis are for reference only. Dimensioning and tolerancing per ASME Y14.5M.
2. This drawing is subject to change without notice.
3. Reference JEDEC MO-178.
4. Body dimensions do not include mold flash, protrusions, or gate burrs. Mold flash, protrusions, or gate burrs shall not exceed 0.25 mm per side.
5. Support pin may differ or may not be present.

# EXAMPLE BOARD LAYOUT

DBV0005A

SOT-23 - 1.45 mm max height

SMALL OUTLINE TRANSISTOR



LAND PATTERN EXAMPLE  
EXPOSED METAL SHOWN  
SCALE:15X



SOLDER MASK DETAILS

4214839/G 03/2023

NOTES: (continued)

- Publication IPC-7351 may have alternate designs.
- Solder mask tolerances between and around signal pads can vary based on board fabrication site.

# EXAMPLE STENCIL DESIGN

DBV0005A

SOT-23 - 1.45 mm max height

SMALL OUTLINE TRANSISTOR



SOLDER PASTE EXAMPLE  
BASED ON 0.125 mm THICK STENCIL  
SCALE:15X

4214839/G 03/2023

NOTES: (continued)

8. Laser cutting apertures with trapezoidal walls and rounded corners may offer better paste release. IPC-7525 may have alternate design recommendations.
9. Board assembly site may have different recommendations for stencil design.

DRL0005A

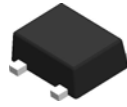

# PACKAGE OUTLINE

SOT - 0.6 mm max height

PLASTIC SMALL OUTLINE

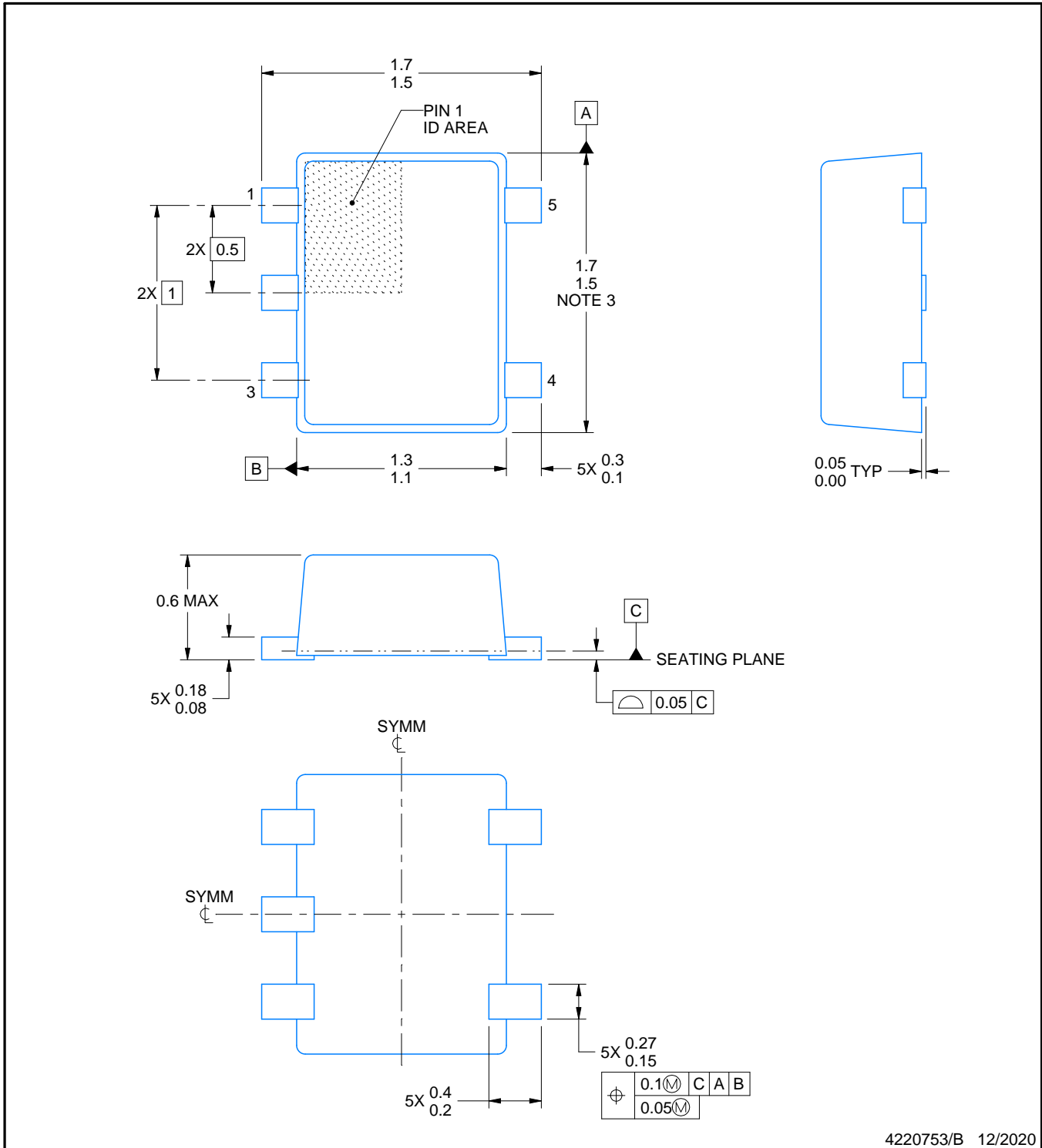

4220753/B 12/2020

## NOTES:

1. All linear dimensions are in millimeters. Any dimensions in parenthesis are for reference only. Dimensioning and tolerancing per ASME Y14.5M.
2. This drawing is subject to change without notice.
3. This dimension does not include mold flash, protrusions, or gate burrs. Mold flash, protrusions, or gate burrs shall not exceed 0.15 mm per side.
4. Reference JEDEC registration MO-293 Variation UAAD-1



# EXAMPLE BOARD LAYOUT

DRL0005A

SOT - 0.6 mm max height

PLASTIC SMALL OUTLINE

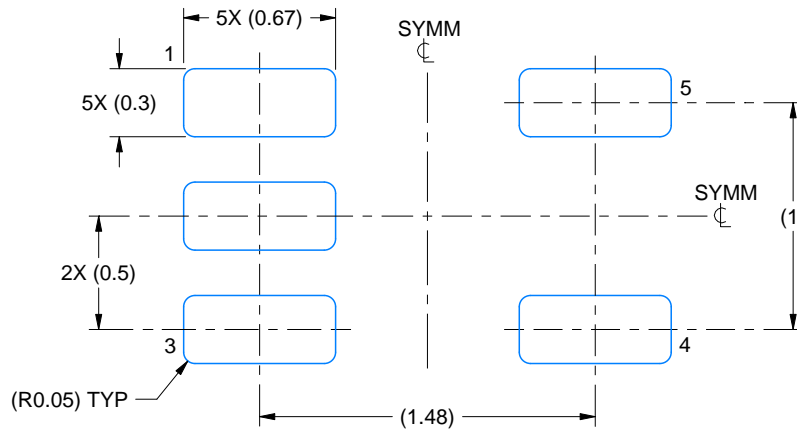

LAND PATTERN EXAMPLE  
SCALE:30X

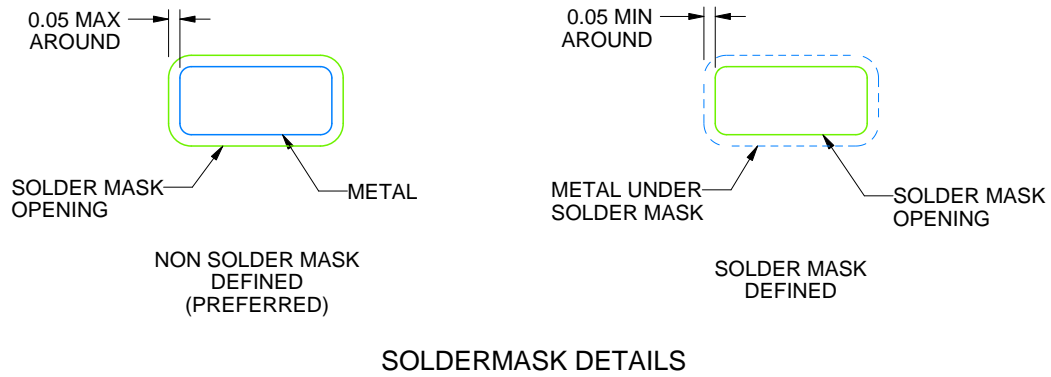

SOLDERMASK DETAILS

4220753/B 12/2020

NOTES: (continued)

- 5. Publication IPC-7351 may have alternate designs.
- 6. Solder mask tolerances between and around signal pads can vary based on board fabrication site.

# EXAMPLE STENCIL DESIGN

DRL0005A

SOT - 0.6 mm max height

PLASTIC SMALL OUTLINE

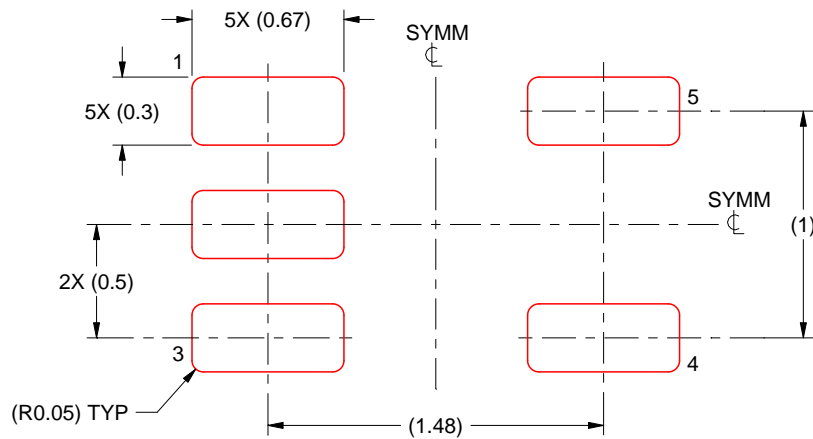

SOLDER PASTE EXAMPLE  
BASED ON 0.1 mm THICK STENCIL  
SCALE:30X

4220753/B 12/2020

NOTES: (continued)

7. Laser cutting apertures with trapezoidal walls and rounded corners may offer better paste release. IPC-7525 may have alternate design recommendations.
8. Board assembly site may have different recommendations for stencil design.

D (R-PDSO-G14)

PLASTIC SMALL OUTLINE

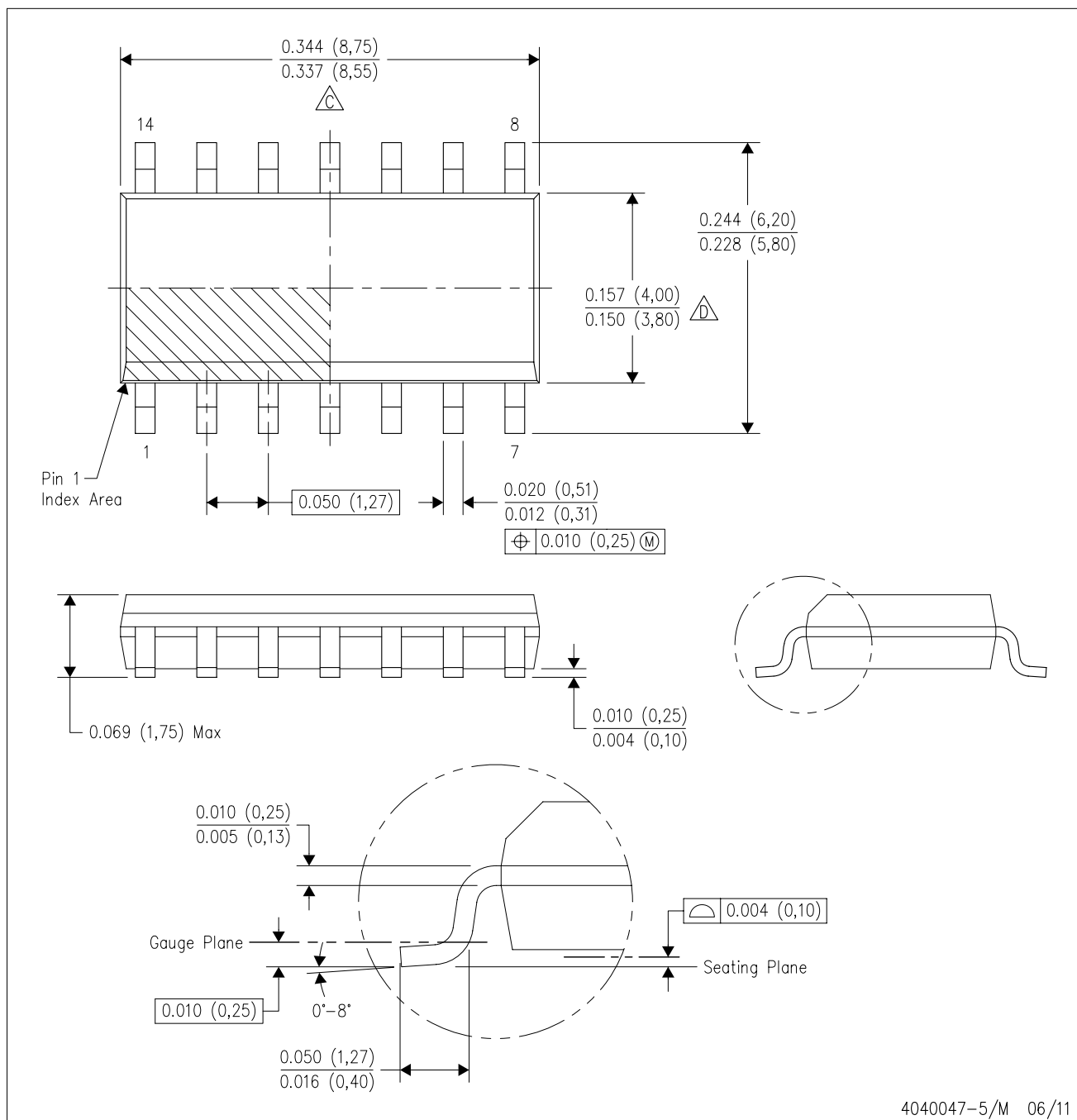

4040047-5/M 06/11

- NOTES:
- A. All linear dimensions are in inches (millimeters).
  - B. This drawing is subject to change without notice.
  - $\triangle C$  Body length does not include mold flash, protrusions, or gate burrs. Mold flash, protrusions, or gate burrs shall not exceed 0.006 (0,15) each side.
  - $\triangle D$  Body width does not include interlead flash. Interlead flash shall not exceed 0.017 (0,43) each side.
  - E. Reference JEDEC MS-012 variation AB.

D (R-PDSO-G14)

PLASTIC SMALL OUTLINE



- NOTES:
- All linear dimensions are in millimeters.
  - This drawing is subject to change without notice.
  - Publication IPC-7351 is recommended for alternate designs.
  - Laser cutting apertures with trapezoidal walls and also rounding corners will offer better paste release. Customers should contact their board assembly site for stencil design recommendations. Refer to IPC-7525 for other stencil recommendations.
  - Customers should contact their board fabrication site for solder mask tolerances between and around signal pads.

# MECHANICAL DATA

PW (R-PDSO-G14)

PLASTIC SMALL OUTLINE



- NOTES:
- A. All linear dimensions are in millimeters. Dimensioning and tolerancing per ASME Y14.5M-1994.
  - B. This drawing is subject to change without notice.
  - C. Body length does not include mold flash, protrusions, or gate burrs. Mold flash, protrusions, or gate burrs shall not exceed 0,15 each side.
  - D. Body width does not include interlead flash. Interlead flash shall not exceed 0,25 each side.
  - E. Falls within JEDEC MO-153

PW (R-PDSO-G14)

PLASTIC SMALL OUTLINE



4211284-2/G 08/15

- NOTES:
- All linear dimensions are in millimeters.
  - This drawing is subject to change without notice.
  - Publication IPC-7351 is recommended for alternate designs.
  - Laser cutting apertures with trapezoidal walls and also rounding corners will offer better paste release. Customers should contact their board assembly site for stencil design recommendations. Refer to IPC-7525 for other stencil recommendations.
  - Customers should contact their board fabrication site for solder mask tolerances between and around signal pads.



D0008A

# PACKAGE OUTLINE

SOIC - 1.75 mm max height

SMALL OUTLINE INTEGRATED CIRCUIT



4214825/C 02/2019

### NOTES:

1. Linear dimensions are in inches [millimeters]. Dimensions in parenthesis are for reference only. Controlling dimensions are in inches. Dimensioning and tolerancing per ASME Y14.5M.
2. This drawing is subject to change without notice.
3. This dimension does not include mold flash, protrusions, or gate burrs. Mold flash, protrusions, or gate burrs shall not exceed  $.006$  [0.15] per side.
4. This dimension does not include interlead flash.
5. Reference JEDEC registration MS-012, variation AA.

# EXAMPLE BOARD LAYOUT

D0008A

SOIC - 1.75 mm max height

SMALL OUTLINE INTEGRATED CIRCUIT



LAND PATTERN EXAMPLE  
EXPOSED METAL SHOWN  
SCALE:8X



SOLDER MASK DETAILS

4214825/C 02/2019

NOTES: (continued)

- 6. Publication IPC-7351 may have alternate designs.
- 7. Solder mask tolerances between and around signal pads can vary based on board fabrication site.



# EXAMPLE STENCIL DESIGN

D0008A

SOIC - 1.75 mm max height

SMALL OUTLINE INTEGRATED CIRCUIT



SOLDER PASTE EXAMPLE  
BASED ON .005 INCH [0.125 MM] THICK STENCIL  
SCALE:8X

4214825/C 02/2019

NOTES: (continued)

8. Laser cutting apertures with trapezoidal walls and rounded corners may offer better paste release. IPC-7525 may have alternate design recommendations.
9. Board assembly site may have different recommendations for stencil design.

DGK (S-PDSO-G8)

PLASTIC SMALL-OUTLINE PACKAGE

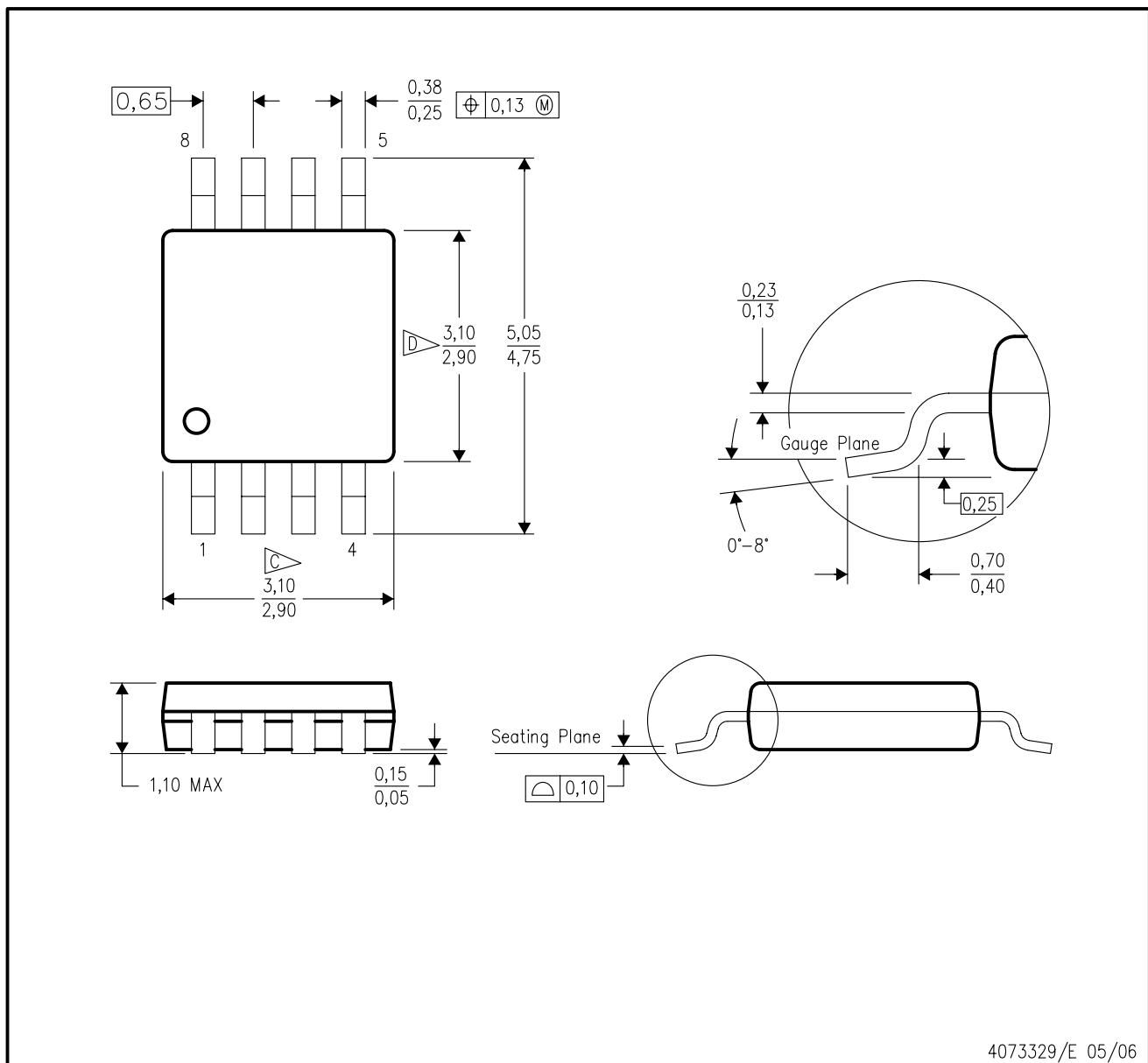

- NOTES:
- All linear dimensions are in millimeters.
  - This drawing is subject to change without notice.
  - Body length does not include mold flash, protrusions, or gate burrs. Mold flash, protrusions, or gate burrs shall not exceed 0.15 per end.
  - Body width does not include interlead flash. Interlead flash shall not exceed 0.50 per side.
  - Falls within JEDEC MO-187 variation AA, except interlead flash.



- NOTES:
- A. All linear dimensions are in millimeters.
  - B. This drawing is subject to change without notice.
  - C. Publication IPC-7351 is recommended for alternate designs.
  - D. Laser cutting apertures with trapezoidal walls and also rounding corners will offer better paste release. Customers should contact their board assembly site for stencil design recommendations. Refer to IPC-7525 for other stencil recommendations.
  - E. Customers should contact their board fabrication site for solder mask tolerances between and around signal pads.

## IMPORTANT NOTICE AND DISCLAIMER

TI PROVIDES TECHNICAL AND RELIABILITY DATA (INCLUDING DATA SHEETS), DESIGN RESOURCES (INCLUDING REFERENCE DESIGNS), APPLICATION OR OTHER DESIGN ADVICE, WEB TOOLS, SAFETY INFORMATION, AND OTHER RESOURCES "AS IS" AND WITH ALL FAULTS, AND DISCLAIMS ALL WARRANTIES, EXPRESS AND IMPLIED, INCLUDING WITHOUT LIMITATION ANY IMPLIED WARRANTIES OF MERCHANTABILITY, FITNESS FOR A PARTICULAR PURPOSE OR NON-INFRINGEMENT OF THIRD PARTY INTELLECTUAL PROPERTY RIGHTS.

These resources are intended for skilled developers designing with TI products. You are solely responsible for (1) selecting the appropriate TI products for your application, (2) designing, validating and testing your application, and (3) ensuring your application meets applicable standards, and any other safety, security, regulatory or other requirements.

These resources are subject to change without notice. TI grants you permission to use these resources only for development of an application that uses the TI products described in the resource. Other reproduction and display of these resources is prohibited. No license is granted to any other TI intellectual property right or to any third party intellectual property right. TI disclaims responsibility for, and you will fully indemnify TI and its representatives against, any claims, damages, costs, losses, and liabilities arising out of your use of these resources.

TI's products are provided subject to [TI's Terms of Sale](#) or other applicable terms available either on [ti.com](https://www.ti.com) or provided in conjunction with such TI products. TI's provision of these resources does not expand or otherwise alter TI's applicable warranties or warranty disclaimers for TI products.

TI objects to and rejects any additional or different terms you may have proposed.

Mailing Address: Texas Instruments, Post Office Box 655303, Dallas, Texas 75265  
Copyright © 2023, Texas Instruments Incorporated